



CHESSE Replacement: New Scope and Implementation Plan

Consultation Paper

April 2018

Invitation to comment

ASX is seeking submissions in response to this paper by 22 June 2018.

Submissions should be sent to:

E: regulatorypolicy@asx.com.au

M: Office of General Counsel
 ASX Limited
 20 Bridge Street
 Sydney NSW 2000
 PO Box H224
 Australia Square NSW 1215

Attention: Cliff Richards

ASX prefers to receive submissions in electronic form.

If you would like your submission, or any part of it, to be treated as ‘confidential’, please indicate this clearly in your submission.

Contacts

For general enquiries please contact:

Keith Purdie – Senior Manager,
 Equity Post-Trade Services
 T: 02 9227 0159
 E: chessreplacement@asx.com.au

Media enquiries, please contact:

Allison Davis - Media and
 Communications Executive
 T: 02 9227 0346
 E: allison.davis@asx.com.au

Contents

Executive Summary	4
New features for the CHES replacement system.....	5
DLT architecture and message interface	6
Indicative migration and implementation plan	6
Ongoing stakeholder engagement	7
Stakeholder feedback requested by ASX.....	7
Next Steps	8
1. Introduction	9
1.1. CHES and equity post-trade services	9
1.2. Technology evaluation process and decision	10
1.3. Stakeholder engagement undertaken.....	12
1.4. Regulator engagement undertaken	14
2. New features for CHES Replacement	15
2.1. Overview	15
2.2. New features to be implemented on Day 1	17
2.3. New features to be implemented separately to CHES Replacement	38
2.4. New features to be implemented through service releases post Day 1	38
2.5. Requirements not being progressed	44
2.6. CHES functionality being decommissioned	46
3. Adoption of ISO 20022 Messaging	47
3.1. Mapping CHES Messages to ISO 20022 Messages.....	47
3.2. Approach to Transition.....	50
4. Non-Functional and Technical Requirements	51
4.1. Availability and Resilience	51
4.2. Recoverability.....	51
4.3. Transactionality	51
4.4. Performance.....	51
4.5. Scalability	52
4.6. Security.....	52
4.7. Provision of Customer Test Facilities.....	52
4.8. Connectivity and Messaging.....	52
4.9. Data Access	53
4.10. Other requirements.....	53
5. Technical Solution for the CHES Replacement System	54
5.1. Introduction	54
5.2. ISO 20022 Interfaces	55
5.3. RBA RITS Interface.....	55
5.4. Browser Interface.....	55
5.5. Data API.....	55
5.6. Networking.....	56

5.7. Security.....	56
5.8. Legacy Functions	56
5.9. Access to ASX’s CS Infrastructure – AMOs and other CS facilities	57
6. Digital Asset (DA) Platform and Node Access	60
6.1. Ledger Components	60
6.2. CHES Replacement Components	61
6.3. Application Layer.....	61
6.4. Platform Layer	62
6.5. Nodes	62
6.6. Direct Node Participation	62
6.7. Direct Node Integration.....	63
6.8. Direct Node Instruction Flow.....	64
6.9. Integration with Existing Systems.....	65
7. Testing and Release Management	66
7.1. High level indicative timeline	66
7.2. Test approach and release management	68
8. Migration and Implementation Approach	70
8.1. Approach	70
8.2. HIN Clean-up	71
8.3. Migration of CHES Holder Registration Details.....	71
8.4. Post Day 1 Release Management.....	71
9. Ongoing Stakeholder Engagement	72
9.1. Business Committee.....	72
9.2. Technical Committee (ISO 20022)	72
9.3. Working Groups	72
9.4. Public Consultations	73
9.5. Webinars	73
Appendix 1 – Corporate Actions STP Phase 2 Project	74
A. Scope of Phase 2.....	74
B. Stakeholder engagement and indicative timing.....	75
C. New features arising from Working Groups being implemented through Corporate Actions STP Phase 2 Project	76
Appendix 2 – New features arising from Working Groups being implemented as ASX Business-As-Usual	81
Appendix 3 – Mapping of business requirements from industry working groups	84
Acronyms	86

Disclaimer

This document provides general information only. ASX limited (ABN 98 008 624 691) and its related bodies corporate (“ASX”) makes no representation or warranty with respect to the accuracy, reliability or completeness of the information. To the extent permitted by law, ASX and its employees, officers and contractors shall not be liable for any loss or damage arising in any way (including by way of negligence) from or in connection with any information provided or omitted or from anyone acting or refraining to act in reliance on this information.

Executive Summary

Introduction

The Clearing House Electronic Subregister System (CHES) is the core system used by ASX to perform clearing, settlement and other post-trade services for the Australian equity market. The replacement of CHES presents a once in a generation opportunity to deliver material benefits for the securities industry and the broader economy. It will also be a major undertaking with significant operational impacts that need to be considered and appropriately managed.

The process of considering the options to replace CHES commenced in 2015. This has culminated in the draft plan outlined in this paper – which is to implement the replacement system based on Digital Asset's (DA) distributed ledger technology (DLT). The new system is currently estimated to commence operation somewhere between Q4 2020 and Q1 2021. The timing of implementation is subject to change following this consultation process, delivery planning that is currently underway, and throughout the lifecycle of the project as the platform is developed. ASX will provide stakeholders with a further update in late July 2018 following this consultation process, as well as regular updates on any changes on an ongoing basis.

Given the opportunity to deliver improvements to investors and listed entities, to the equity post-trade operations of intermediaries, and recognising the operational impacts of replacing CHES, ASX undertook a two and a half year assessment of DLT and conducted an extensive stakeholder engagement process. This included:

- collecting and assessing user inputs to business requirements through an extensive consultation process across a diverse set of users during 2017;
- a rigorous process, including initial independent 3rd party technology assessments, to enable ASX to assess the functional, capacity, security and resilience capabilities of DA's DLT-based platform for use as the basis of the new system and to confirm that it will meet the needs of Australia's equity market (including for improved record keeping, reduced reconciliation, more timely transactions and better quality data) and maintain the highest regulatory and operational requirements;
- a comprehensive review of the architecture of DA's DLT-based platform to assess its capability to enable customers to choose whether to use message based interaction (as is available in CHES today) or to integrate more fully with the platform and access the data sharing benefits that this provides. This review also included an assessment of the Digital Asset Modelling Language (DAML) - an advanced smart contract programming language, and the software development kit (SDK) that will enable customers and their software vendors to independently develop applications on top of the platform provided by ASX; and
- reviewing, in conjunction with industry experts, the existing CHES message structure, identifying redundant or seldom used messages and mapping the remainder to the new ISO 20022 global messaging standard.

This has allowed ASX to gain a comprehensive understanding of the functionality and services that can be delivered by the new system, as well as determining what users of CHES will need in order to reduce costs, risk and improve customer experiences.

ASX thanks all those who gave considerable time and expertise (through the Business Committee, ISO 20022 Technical Committee, industry working groups, and other stakeholder meetings) to help develop the scope of enhancements that will be delivered as part of the CHES replacement system.

This paper sets out the enhancements that ASX will deliver in the new system through new business functionality and the decommissioning of some redundant services. It describes the system architecture for

the DLT-based model, connectivity options, the draft plan for implementation of the new features, and the testing and transition arrangements.

ASX's assessment process

Following the completion of the user consultation on business requirements in November 2017, ASX has conducted an assessment of each of the requested business requirements to determine whether they will be included in the new system. This assessment took into account the technical, operational, risk and regulatory implications for these requirements as well as the need to manage the transition phase in a safe, efficient and effective manner. For some of the new requirements, the uncertainty that all relevant risk and regulatory implications will be able to be addressed in time for the first release of the system means that they may not be available for use on Day 1 even if the system supports this functionality.

In determining the functionality that is targeted to be delivered, ASX is also responding to strong stakeholder feedback that, as much as possible, the new system should contain enhancements that maximise the efficiency benefits for users on Day 1.

In determining the transition and timing of the delivery of the new system, ASX has taken into consideration the need for users to have sufficient time to prepare for the implementation of the new system. This includes developing the technology solutions they will choose to connect to CHES, considering the different connectivity options that are available and the functionality they wish to use in the new system, and undertaking the significant system testing that is required.

ASX has sought to balance the demand for new functionality on Day 1, against the need to deliver the new system in a reasonable timeframe - recognising that further enhancements can be made to the new system once implemented. ASX has therefore categorised the implementation of requirements into those that are targeted to be delivered on Day 1, those that will be delivered in releases post Day 1, and those that will be implemented separately as they are not dependent on CHES replacement.

The Day 1 functionality for the new system will be finalised once ASX has considered stakeholder input from this consultation process.

New features for the CHES replacement system

Approximately 50 new business requirements have been identified through consultation with stakeholders over the past 18 months. These include new functional business requirements captured through the stakeholder working group process, requirements identified through other stakeholder input, as well as a set of non-functional business requirements.

These new business requirements relate to areas as diverse as: account structures and information; pre-settlement; settlement; and corporate action processes. In addition, the replacement system will need to meet high non-functional and technical requirements in relation to: availability and resilience; recoverability; performance; scalability; and security.

A list of the relevant changes and where they fall within the implementation plan are set out in Chapter 2. This Chapter also includes a description of the 8 business requirements captured through the stakeholder working group process that are not being implemented and some existing CHES functionality that will be decommissioned.

Some of the requirements will be addressed through separate processes, either as part of the Corporate Actions STP Phase 2 Project which will commence shortly or as ASX business as usual projects. These requirements and the process to progress them are explained in Appendices 1 and 2.

DLT architecture and message interface

ASX will replace CHESSE with a post-trade solution that provides users with more efficient clearing, settlement and other post-trade services through improved record keeping, reduced reconciliation, more timely transactions, and better quality data.

The new system incorporates a permissioned distributed ledger that will provide benefits for users. However, ASX recognises that users will require flexibility as to how they connect to the new system. Users may choose to connect and transact by sending and receiving messages in a similar way as today or they may choose to take a DLT node and interact directly.

The DAML Software Development Kit (DAML SDK) being offered by DA will enable stakeholders to develop DAML based applications that integrate directly with a DLT node. This will allow them to leverage data and services they are permitted to access and facilitate real time and deeper integration into their existing processes.

For those using message based interaction, ASX has previously announced its intention to replace the proprietary CHESSE message protocol with the global standard of ISO 20022. This will streamline the existing suite of messages, facilitate more efficient processing and provide a richer data set.

All permissioned users will also be able to request and access data they are entitled to through a modern, secure Application Programming Interface (API).

All users, regardless of their connection choice, will be subjected to an on-boarding process governed and managed by ASX.

The new technology, accompanied by a commitment to use global message standards and APIs, will facilitate non-discriminatory access to market operators (including non-ASX affiliated operators) and/or other licensed clearing and settlement facilities.

Indicative migration and implementation plan

The dates provided in the timeline below and other dates for testing, release management, migration and implementation activities set out in this paper are indicative dates only. These dates represent ASX's best estimate, at the time of publishing this paper, for commencement and completion of the activities.

The indicative go-live window for the new system is Q4 2020 to Q1 2021. ASX is proposing a single cutover weekend from CHESSE to the new system, based on feedback from stakeholders and the positive experience with other more recent transitions being conducted on a similar basis (implementation of the new derivatives trading platform and the move to a T+2 settlement cycle).

To assist customer readiness, ASX will provide customer test facilities for functional, non-functional and migration testing. ASX is aiming to commence incremental software drops into externally available test environments from Q2 2019 and to have the majority of the functionality available for industry-wide testing by Q1 2020. This will provide customers with at least 8 months for most functional, non-functional and formal accreditation testing, based on the earliest estimated implementation date.

Migration testing is planned to begin in June 2020 and will culminate with migration dress rehearsal weekends in preparation for go-live. Successful industry-wide testing and dress rehearsal weekends are required for go-live and will then allow a primary and backup go-live weekend to be scheduled, taking industry feedback into consideration.

Indicative High-level Timeline	2018				2019				2020				2021
	Q1	Q2	Q3	Q4	Q1	Q2	Q3	Q4	Q1	Q2	Q3	Q4	Q1
ASX Analysis, Build & Test (iterative)	[Active]												
Corporate Actions STP Phase 2		[Active]											
Documentation Release (iterative)			[Active]										
Customer Analysis, Build & Test			[Active]										
Customer Development & Test Environments					[Active]								
Industry Wide Testing									[Active]				
Accreditation Testing													
Indicative Go-Live Window (Date TBC)													

Ongoing stakeholder engagement

ASX will continue to engage with stakeholders, including throughout the development, testing and implementation phases leading up to the commencement of the new system.

The Business Committee will continue to play a role in providing high-level input to the Boards of ASX Clear and ASX Settlement on the functional requirements and implementation processes.

The ISO 20022 Technical Committee will continue to provide a mechanism for ASX to engage on the introduction of ISO 20022 messages to replace CHES messages over at least the next 12 months.

ASX will also continue to support the Approved Market Operators (AMOs) working group to address matters such as connectivity of trading systems.

Two new working groups will be established, drawing on a broad range of expertise from system users and other stakeholders (including AMOs), to facilitate transition planning:

- Connectivity and Integration Working Group – regular meetings to assist users to manage their connectivity to test and production systems and assess the different options for integration.
- Implementation and Transition Working Group – regular meetings to inform users’ implementation and transition plans.

In addition, ASX will use focused stakeholder groups and consultation, where necessary, to assist in developing the new system. A range of regular public communications tools (such as webinars, market notices, and updates to the dedicated CHES replacement website) will keep the market updated on the progress of the transition arrangements.

Stakeholder feedback requested by ASX

The new functional business requirements of the new system have been subject to extensive and detailed industry input. The connectivity options, as well as the proposed migration and implementation plan, have not been consulted on previously.

ASX invites feedback from users and other stakeholders on the following questions to assist in planning for the delivery of the new system:

- Are there any important new business requirements that are not captured in Chapter 2 (or otherwise in Appendices 1 or 2) that should be included? If so, your feedback must provide a detailed description of the business requirement and outcome sought, process flow(s) to support the requirement, a supporting rationale, any relevant stakeholder input and regulatory considerations.
- Do you have specific feedback on the proposed testing and release management strategy (Chapter 7) and the proposed migration and implementation approach (Chapter 8)?
- Is there particular information that you will need to assist you with your transition planning?

Next Steps

Written submissions must be provided to ASX by 22 June 2018.

If you would like your submission, or any part of it, to be treated as 'confidential', please indicate this clearly in your submission. Submissions marked 'confidential' may still be shared with relevant regulators.

After ASX has considered the consultation responses, it will publish the final Day 1 functional scope of the new system and a roadmap for future stakeholder engagement, technical document release and implementation timing for CHES replacement.

Depending on the extent of consultation feedback received, ASX expects to provide a final functional scope and implementation roadmap in late July 2018.

1. Introduction

1.1. CHES and equity post-trade services

CHES is the core system used by ASX's licensed clearing and settlement facilities (ASX Clear and ASX Settlement) that was implemented in 1994 to perform the clearing and settlement of trades, asset registration and other post-trade services for the Australian equity markets. The reliable performance of these post-trade functions support orderly markets and reduce risk in the Australian financial system.

CHES was developed approximately 25 years ago to provide the cash market with name on register, and a full automation of an irrevocable delivery versus payment (DvP) for settlement of market transactions together with the automated processing of associated corporate actions. This was considered to be world-leading financial market infrastructure at the time. As a result, the development of proprietary electronic messaging was necessary because existing message standards lacked the sophistication to accommodate CHES' functionality. CHES enabled the successful dematerialisation of the equity market (the conversion of physical shares into an electronic format) and the transition to shorter settlement cycles with the move from T+5 to T+3 in 1999 and to T+2 in 2016. CHES has also supported improved efficiency in, and effectiveness of, post-trade processing.

1.1.1 Clearing services

Securities cleared and settled in CHES include shares, warrants, units of listed trusts, units in exchange-traded funds (ETFs), managed fund units, CHES Depository Interests (CDIs), unsecured notes, convertible notes, Australian Government Bonds (AGBs) and other interest rate securities.

Trades executed on an AMO¹ are submitted to CHES for registration. Once accepted, by way of novation, each cash market trade between AMO trading participants is replaced with a cash market central counterparty transaction between each clearing participant for that trade and ASX Clear. Novation does not take place for crossing trades (where the same clearing participant acts for both the buyer and the seller) and the clearing participant receives optional notification of the trade for information only.

On the evening of Trade Date ('T'), ASX Clear replaces all eligible novated settlements with one net settlement per settlement date, per participant, and per security. The netting of gross positions substantially reduces the financial flows and capital requirements associated with clearing.

Generally, where a security is subject to a corporate action event, the netting facility is turned off and the gross transaction is retained through to the settlement cycle. This enables ASX Settlement to apply high levels of automated buyer protection.

The resulting gross or net settlement lines are then subject to scheduled settlement by ASX Settlement.

During 2017, CHES delivered an average netting performance of 99% on trade volume and 62% on trade value.

1.1.2 Settlement services

Transactions on Australian equity securities markets are settled on a trade date plus two business days (T+2) settlement cycle, where the seller has an obligation to deliver 'sold' securities on the second business day after the transaction, and the buyer has an obligation to pay for those securities on that same day.

¹ Approved AMOs that currently submit trades for clearing and settlement are ASX Limited and Chi-X Australia Pty Limited.

Securities transactions settle on a net basis in a single daily batch cycle which involves locking securities scheduled for settlement and the determination of each participant's net funds and security delivery obligations, and the net funds obligations of all participants' banks. Once payment of funds has occurred, the movement of securities is triggered from delivering to receiving settlement participants within CHES.

CHES affects settlement of transactions by transferring the title or legal ownership of the securities at the same time as the transfer of money for those securities between participants via their respective banks, known as delivery versus payment (DvP).

Investors can choose to have their holdings registered in one of two ways, on:

- the CHES sub-register, or
- an issuer sponsored sub-register.

The two types of sub-register provide alternate forms of registration for security holders and the securities they own. Nearly all issuers with quoted securities manage their own issuer sponsored sub-register for the registration of their securities. This form of registration is also referred to as being 'issuer sponsored', and is typically managed by a share registry on behalf of the issuer.

Alternatively, every issuer's securities can be registered on the CHES sub-register which allows settlement participants to manage their sponsored clients' security holdings, while the client retains legal title to those security holdings. This form of registration is also referred to as 'broker sponsored'. CHES facilitates communication between participants and issuers' share registries to maintain and update holder information on the CHES sub-register. Eighty one per cent of all holdings in listed ordinary shares (by value) were held on the CHES sub-register as at 3 April 2018.

1.1.3 Other post-trade services

CHES also facilitates other post-trade services, including:

- The provision of monthly CHES holding statements to holders to notify any changes to their holdings on the CHES sub-register.
- Support for corporate action events by providing the establishment of a CHES sub-register (as needed), suspension of processing on a CHES sub-register for a reconstruction, daily cum entitlement balances, and adjustments and accruals for dividends, rights issues or other corporate action benefits owed or owing (diary adjustments).
- Settlement of managed funds via the mFund settlement service, which enables investors to apply for and redeem units in unlisted managed funds directly with the mFund issuer via a stockbroker or advisory services used to transact shares or other products.

1.2. Technology evaluation process and decision

In December 2017, ASX announced its intention to replace CHES using a distributed ledger technology (DLT) based system developed by Digital Asset (DA). This decision was taken following a two and a half year rigorous technology partner selection and software evaluation process.

The evaluation process included the successful build of an enterprise-grade DLT-based platform for core cash equity clearing and settlement functions and extensive suitability testing by ASX and DA. The testing confirmed that the functional, capacity, security and resilience capabilities of the platform could meet the needs of Australia's equity markets and meet the highest regulatory and operational standards.

ASX commenced its process for evaluating replacement options for CHES in 2015. This included an examination of the potential application of DLT and the global search for a vendor focused on the

development of DLT software for financial markets. In January 2016, ASX selected DA as a technology partner to develop, test and demonstrate a working prototype of a DLT-based post-trade platform for the equities market with the initial phase of work on the development of a prototype completed in mid-2016.

Following successful completion of the prototype phase that including positive feedback from stakeholders, in the second half of 2016 DA commenced the development of enterprise-grade software to enable ASX to further assess the capabilities of DA and the suitability of its technology with the goal of enabling ASX to decide by the end of 2017 whether to use DA technology to replace CHES. ASX's assessment was focused on whether the DA technology can: perform base level equity clearing and settlement functionality while meeting scale and throughput requirements; model CHES workflows; meet security, resilience and scalability requirements; and be used by ASX and 3rd parties to develop new services.

1.2.1 Enterprise-grade software development and testing

The scope of the clearing and settlement software build for the purpose of the end of 2017 decision represented approximately 70-80 percent of current CHES message volume, covering:

- Participant and security definition – the creation and maintenance of the legal entities required to facilitate the activities of a clearing and settlement system.
- Trade registration – the ability to accept, register and confirm trades from market operators.
- Pre-settlement netting – the netting of all market trades in each security per participant under model 3 DvP settlement.
- Settlement – implementation of the settlement algorithm and DvP settlement of novated and non-novated transactions.
- Corporate actions – the creation of any relevant cum entitlement balances, their management and any consequential changes to investor holdings.

ASX also tested the non-functional capabilities of the platform. Testing of non-functional requirements (NFRs) was prioritised in the following areas: security; performance and throughput capacity; stability and resilience; and scalability. ASX's NFRs and associated tests took into account regulatory requirements.

Testing of the functional and non-functional requirements was conducted in both the AWS (Amazon Web Services) Cloud and ASX data centre hosted environments using production sourced trade and reference data. Any trade and reference data used for this testing that was not publicly available was anonymised. DA was able to demonstrate that the system met the NFRs in an AWS environment configured in the same way as the ASX environments prior to ASX conducting tests on its own infrastructure.

ASX developed and used automated regression testing for a significant portion of the testing undertaken in 2017 to reduce human error and provide for efficient repeatability of tests. Some manual testing was used for the testing of complex corporate actions (rights issues).

ASX concluded that DA successfully delivered the specified scope on schedule, through a number of software releases addressing functional and non-functional requirements, and consistent with the required service levels, acceptance criteria, software delivery milestones and post-release retrospectives.

The pass rates for testing ASX's functional and non-functional requirements were high and met agreed criteria. The software delivered also exhibited low defect counts and DA responded with rapid defect resolution fix times, both of which exceeded ASX's requirements.

1.2.2 Third-party security assessments

ASX commissioned two third-party security reviews of DA's technology. The scope of the third-party reviews covered 50 specific security functionality claims and requirements implemented in the platform, and another 5 'specific threats addressed' claims made by DA. The 55 claims subject to the reviews were categorised into the following areas:

- Trust assumptions
- Identity, authentication and authorisation
- Special authorisation for regulators and auditors
- Confidentiality and privacy
- Integrity
- Non-repudiation
- Replay detection and prevention
- Logging
- Cryptographic functions
- Specific threats addressed

The two reviews used the same scope and were performed independently of ASX and each other. Neither of the reviews revealed to ASX any threshold issues of concern regarding the security of DA's technology nor any material inconsistencies between their findings.

Further reviews will be undertaken prior to implementation of the new system.

1.3. Stakeholder engagement undertaken

1.3.1 Public consultations

Over the past 18 months, ASX has undertaken comprehensive stakeholder consultation to gain a comprehensive understanding of the new functionality and services that stakeholders of CHESSE would like delivered by the new system. This process commenced in September 2016 with the release of a public consultation paper '[ASX's Replacement of CHESSE for Equity Post-Trade Services: Business Requirements](#)'. At the request of the Business Committee, ASX also released a [supplementary questionnaire](#) in December 2016 to seek further feedback on specific topics.

1.3.2 Business Committee and Technical Committee

Over the past 18 months, ASX's [Business Committee](#) for equity clearing and settlement services and ASX's [Technical Committee](#) for the adoption of ISO 20022 messaging have met more frequently and focused on providing input to CHESSE replacement. Over the course of six meetings during 2017, the Business Committee was updated on the progress of ASX's investigation of DA's DLT-based system, and provided input on the strategy and business requirements for the system that replaces CHESSE and ASX's approach to consultation with users.

The Technical Committee on ISO 20022² met eight times during 2017, with a focus on mapping existing CHESSE messages to ISO 20022 messages, reviewing and de-scoping redundant CHESSE messages, and how to

² Further information on the Technical Committee, including membership details and meeting papers, is available on the [CHESSE Replacement section of the ASX website](#).

manage the transition process. The Technical Committee has also been provided with a subset of core CHES functionality messages (including trade registration, clearing, settlement, holding management) for review and comment. The Technical Committee is expected to meet at least eight times during 2018 as the key industry consultative mechanism for the development of the final suite of ISO 20022 messages.

Further information on the adoption of ISO 20022 messaging is provided in Chapter 3 (Adoption of ISO 20022 Messaging).

1.3.3 Working Groups

ASX convened six CHES Replacement Working Groups³ to elicit industry input on business requirements, and their relative priority. ASX also convened a separate Working Group for Approved Market Operators (AMOs) to obtain input on their business requirements.

The topics discussed by the Working Groups were based on the feedback ASX received from stakeholders through the September 2016 public consultation, the supplementary questionnaire, and the bilateral meetings and workshops undertaken. The six Working Groups convened were:

- Account structures and participant models
- Corporate actions
- Transfers and conversions
- Settlement enhancements
- Data storage, delivery and reporting
- Non-functional requirements

In total, there were 13 Working Group meetings held between May and November 2017. The Working Groups provided input on 40 functional and 5 non-functional requirements. At the end of the process, participants were provided with an online survey and asked to prioritise each of the 40 functional business requirements according to whether they were of a high, medium or low priority to their organisation. This provided ASX with another input to assist in gauging the relative importance of each of the business requirements to different stakeholder groups. It has also provided a further useful input to ASX's decision-making process for determining the Day 1 scope of the new system.

1.3.4 Issuers engagement

ASX has engaged with issuers to discuss the business requirement input received from other stakeholders in areas of direct relevance to them, and to obtain feedback on new and improved issuer services that could be provided by the new system. A series of 12 issuer roundtable discussions were held in Perth, Sydney and Melbourne in November 2017 and February 2018. These sessions were attended by 70 listed companies, representing a total market capitalisation of \$820 billion or more than one-third of total Australian market capitalisation. ASX also consulted with the 4 largest exchange traded product (ETP) issuers with a combined funds under management (FUM) of \$30.9 billion representing approximately 85% of FUM of the entire Australian ETP market⁴.

³ The working groups comprised clearing and settlement participants, custodians, issuers' share registries, approved market operators, issuers, investor industry associations, and their representatives.

⁴ ETPs includes exchanged traded funds and other actively managed traded funds.

1.3.5 Other stakeholder engagement

In addition to these formal public consultation processes, ASX undertook 88 technical demonstrations with nearly 600 attendees and a number of more detailed workshops with users and other stakeholders. The purpose of the demonstrations and workshops was to showcase the DLT prototype and system architecture so that users could gain an understanding of the capabilities of a DLT-based platform. This was also to help users when providing input to ASX on what they wanted from the new system.

Further information is provided on the input received from stakeholders on business requirements relating to CHES replacement in Chapter 2 and also in Appendices 1 and 2.

ASX has endeavoured to keep all stakeholders informed of progress of the CHES Replacement Project through the [CHES Replacement section of the ASX website](#) and through the provision of quarterly webinar industry updates. There were 4 webinar updates held during 2017 with an average of 150 connections for each session.

1.4. Regulator engagement undertaken

ASX provided the Australian Securities and Investments Commission (ASIC), the Australian Competition and Consumer Commission (ACCC), the Reserve Bank of Australia (RBA) and Treasury with five briefings in February and March 2018 on the new features outlined in this paper. These briefings have been informational only, and have not been a forum where ASX has sought (or obtained) any regulatory approvals. When appropriate, ASX will engage with the applicable regulators to obtain all necessary approvals in connection with the new features for the CHES replacement system as well as new features being addressed through the separate processes outlined earlier.

ASX also shared a draft of this consultation paper with the ACCC, ASIC, RBA and Treasury. While ACCC, ASIC and RBA have provided feedback on this draft, this should not be taken to imply that the paper, or any particular functionality described in the paper, have regulatory approval.

2. New features for CHES Replacement

2.1. Overview

This chapter sets out the changes that will be delivered in connection with the new system through approximately 50 new business requirements and the decommissioning of a handful of redundant CHES functionality.

These changes represent ASX's approach to the new business requirements generated during the industry working groups in 2017 and some additional business requirements identified separately by ASX.

ASX has conducted an assessment of each of the business requirements to determine whether they should be included in the new system. This assessment took into account the technical, operational, risk and regulatory implications for the new business requirements, the extent to which the requirements overlapped, as well as the need to manage the transition phase in an efficient and effective manner.

The table on the following page provides a high level overview of the business requirements being implemented in the new system. There are a group of other business requirements that were raised during the working group process but which are more appropriately progressed separately as they are not dependent on the replacement of CHES. These are set out in more detail in Appendices 1 and 2.

Access arrangements for Approved Market Operators which are set out in Section 5.9 will also be implemented on Day 1.

There are eight business requirements identified during the working groups that are not being implemented. The reasons for not proceeding with these measures is set out in Section 2.5. Some existing redundant CHES functionality will not be transitioned into the new system.

The new system will be able to support, at a technical level, the new business requirements on Day 1 (as specified in Section 2.2 and subject to this consultation process). Whether the functionality of some of these requirements is available to users by Day 1 is dependent on the associated risk and regulatory implications and the need to obtain the necessary regulatory clearances. As indicated below, the level of risk and regulatory impact varies across the new requirements and so, for some of the requirements there is greater uncertainty that these can be addressed by Day 1. ASX also plans that additional business requirements will be supported through service releases post Day 1. The additional business requirements currently planned (and known at this time) for post Day 1 are specified in Section 2.4 and subject to the consultation process.

Targeted to be implemented on Day 1	To be implemented via releases post Day 1	To be implemented separately to CHESS replacement
<p>Account information</p> <ul style="list-style-type: none"> • Common investor number • Additional investor information • Centralised data capture & storage • Standardised registration details <p>Pre-settlement</p> <ul style="list-style-type: none"> • Settlement lock for CHESS holdings • Bilateral transaction matching • Transfer of novated equity transactions between CPs • Additional preliminary payment notifications • Settlement lock for issuer sponsored holdings • Single access point to validate SRNs <p>Settlement</p> <ul style="list-style-type: none"> • Non-batch DVP bilateral settlement • Settlement message enhancements • Settlement in foreign currencies • Optional early settlement • Auto-borrow <p>Corporate Actions</p> <ul style="list-style-type: none"> • Electronic DRP & BSP elections • Electronic acceptance of entitlement offers • Electronic payment for entitlement offers • Transfer of CUM entitlement balance <p>Reporting</p> <ul style="list-style-type: none"> • Continuous holding balance information • Electronic provision of holding statements and notifications <p>mFund</p> <ul style="list-style-type: none"> • Real-time cash settlement, 'hold' status and transfer capability • Sharing of investor details, automation of regular payments and switching between funds 	<p>Account information</p> <ul style="list-style-type: none"> • Aggregated view of holdings <p>Corporate Actions</p> <ul style="list-style-type: none"> • Electronic processing of dividend claims • Electronic proxy voting <p>Participant structures</p> <ul style="list-style-type: none"> • Participant models for clearing and settlement services 	<p>Corporate Actions STP Ph2</p> <ul style="list-style-type: none"> • Electronic single access point for corporate action event info • Transparency through the life cycle of corporate actions • Standardised DRP & BSP elections • ISIN for entitlement in non-renounceable rights issues • Spin-offs involving entitlements in securities in foreign jurisdictions • Share purchase plans • Review deferred settlement trading processes <p>ASX BAU</p> <ul style="list-style-type: none"> • Transfer between sub-registers – Custodian off-market transfers • Corporate actions - Takeover offers

For ease of reference ASX has provided a mapping of the business requirements raised during the working group process to the table above (see Appendix 3). In some cases parts of business requirements have been combined, or split, to most effectively manage the implementation process.

To assist in planning for the delivery of the new system, ASX invites the following feedback:

- Are there any important new business requirements that are not captured in Chapter 2 (or otherwise in Appendices 1 or 2) that should be included? If so, your feedback must provide a detailed description of the business requirement and outcome sought, process flow(s) to support the requirement, a supporting rationale, any relevant stakeholder input and regulatory considerations.

2.2. New features that are targeted to be implemented on Day 1

This section explains for each of the new business requirements targeted for Day 1, the rationale, the feedback received from stakeholders during the working group processes, and the anticipated regulatory implications. Further risk and regulatory analysis will be required to support implementation of the specific solution that is developed for each requirement.

In reviewing this section, it is important to note that the availability on Day 1 of the functionality supporting these requirements is subject to addressing any associated risk and regulatory implications and obtaining the necessary regulatory clearances. To resolve these issues, the viability of providing the new functionality may be impacted. In these instances, ASX will work with stakeholders to see if an alternate solution can be identified.

2.2.1 Account information – Common investor number

The new system will allow settlement participants to be able to request that ASX generate a Common Investor Number (CIN) as an investor identifier which can be linked to CHESS and issuer sponsored holdings. The request for, and use of, a CIN will be optional.

The CIN will relate to a client of a settlement participant, including those financial products that are held in a CHESS holding sponsored by a settlement participant, held through a nominee company operated by a Settlement Participant, or are issuer sponsored holdings acquired using the services of a settlement participant. Investors that acquire shares via a non-market channel (e.g. in the case of a demutualised issuer) will not be able to have a CIN until they engage with a settlement participant.

CINs will be in addition to:

- holder identification numbers (HINs) generated by ASX to identify registered legal owners of financial products on the CHESS sub-register; and
- securityholder reference numbers (SRNs) generated by issuers (typically through their share registry) to identify registered legal owners of financial products on the issuer sponsored sub-register.

Where the registered legal owner for a holding is also the investor for that holding, the CIN and the HIN or SRN (as applicable) will relate to the same person. If however the registered legal owner is not the investor for that holding, the CIN and the HIN or SRN (as applicable) will relate to different persons. For example, for a settlement participant holding financial products on behalf of several investors through a nominee company, separate CINs will be allocated to each of those underlying investors, while a single HIN or SRN (as applicable) will apply to the settlement participant's nominee company.

As the CIN will be an identifier specific to a person, the same CIN can be used for each of the holdings for which that person is the investor, including if the person is the client of various settlement participants.

Rationale

The requirement provides the ability to generate a consolidated portfolio view of holdings in which a client has an economic interest based on a CIN specific to that client. This is expected to be particularly useful to persons holding financial products:

- directly using more than one sponsoring participant;
- directly both individually and jointly;
- directly across different issuers which are held as issuer sponsored holdings;
- indirectly via brokers and/or custodians through their nominee company;
- indirectly via a trustee entity; or

- indirectly through a self-managed superannuation fund (SMSF).

Stakeholder input

The Account Structures and Participant Models Working Group requested that the new system have flexibility to support and enhance the current omnibus/custody model, including on the basis that it will increase timely transparency of ownership and control of securities.

Regulatory considerations

Further consideration of the privacy implications of the collection, storage, use or disclosure of personal information associated with a CIN is required to support this requirement.

Amendments to the ASX Settlement Operating Rules will be required to establish the process for the provision of information by settlement participants to ASX for the generation of CINs, the notification by ASX to settlement participants and clients of CINs allocated, and any restrictions on the disclosure of CINs.

2.2.2 Account information – Additional investor information

The new system will facilitate the input by settlement participants of additional investor information which can be linked to a CHESS holding to facilitate the extension of certain corporate actions to the underlying beneficiaries of such financial products.

For example, the additional investor information could include:

- investor name and address;
- number of financial products (e.g. 100 CBA and 250 WBC shares) held in respect of that investor.

This information will be additional to the registered holder information currently obtained⁵.

Rationale

The requirement is expected to streamline corporate action processing for nominee holdings.

In the case of share purchase plans (SPPs) for example, where a settlement participant provides custodial services through their nominee company (e.g. a custodian), that investor information could be used to notify the underlying beneficiaries to the issuer's registry for the entitlement of shares under SPPs, i.e. so that the size of the SPP made available to the custodian is determined based on the number of underlying beneficiaries for the holding – where the issuer elects to extend the SPP on that basis.

The greater efficiencies for issuers, settlement participants and underlying beneficiaries has the potential to make it more attractive for issuers to extend corporate actions, e.g. SPPs, to underlying beneficiaries and for settlement participants and underlying beneficiaries to process acceptances into the corporate action.

Stakeholder input

The Account Structures and Participant Models Working Group and the Corporate Actions Working Group provided input to ASX relevant to this requirement. The Working Groups supported this requirement on the basis that it will assist in facilitating more timely transparency of ownership and control of securities and participation in SPPs.

⁵ Holder's name, address, email details (if any) and residency indicator.

Regulatory considerations

The Corporations Act prohibits any notice of trust, whether express, implied or constructive, being entered on a register, other than in the limited circumstances (e.g. trustees on death, incapacity or bankruptcy of shareholder or with company's consent)⁶. This applies to information recorded on the CHESS sub-register.

However, the ATO requires that for SMSFs, the title of fund assets should be in the name of the current trustee of the fund 'as trustee for' the fund. This extends to financial products recorded on the CHESS sub-register for an issuer⁷.

The replacement of CHESS provides an opportunity to reassess the inconsistencies between these regulatory requirements. This is necessary if the additional holding information is to be able to indicate that financial products are held on behalf of another person.

Consistent with existing ASX Settlement Operating Rule 8.10.3, the operating rules will expressly provide that ASX need not recognise any interest or right in respect of a financial product other than the absolute right of legal ownership by the registered holder. Further consideration will also be given to whether there should be any additional legislative support for this approach.

ASIC Regulatory Guide 125 and Class Order 09/425 contain written certification requirements from custodians⁸ in respect of the application for shares under the SPP. This includes, for example, for each beneficiary, their name and address (and those of any interposed custodians) and that the beneficiary's total applications under similar arrangements in the last 12 months do not exceed \$15,000. Further consideration will need to be given to how the written certification requirements will be satisfied when beneficiary information is provided through the new system or if relief is required under Class Order 09/425.

Further consideration of the privacy implications for the collection, storage, use or disclosure of personal information associated with the additional investor information is required to support this requirement.

Amendments to the ASX Settlement Operating Rules will support the process for provision of the additional information by settlement participants to ASX, the notification by ASX of that information to issuers and any restrictions on the disclosure of that information.

2.2.3 Account information – Centralised data capture and storage

The new system will capture and store additional information linked to a CHESS holding which can be used in connection with corporate actions, compliance with regulatory obligations and new investor services as requested by stakeholders.

The additional information could include: tax file number (TFN); Australian business number (ABN); legal entity identifier (LEI); bank account details; and dividend reinvestment plan (DRP) details.

⁶ Section 1072E(10) Corporations Act.

⁷ This inconsistency between general notice of trust prohibitions under the Corporations Act and specific ATO requirements for SMSFs has led to the following attempted workaround on the CHESS sub-register:

- SMSF trustee identified as registered holder of financial products (e.g. 'SMSF Trustee Pty Limited'); and
- Name of SMSF identified in parenthesis in a separate designation field attached to registered holder (e.g. '<Jane Smith Super Fund>').

⁸ References to custodian in this requirement are to the broader custodian concept referred to in ASIC Regulatory Guide 125 and Class Order 09/425 which extends to trustees of SMSFs, REs of IDPS (investor directed portfolio service) like schemes (e.g. master fund or wrap account), or a person who is noted on the register of members as holding shares or interests on account of another person.

Rationale

The capture and storage of such information will allow better support of corporate actions and also the provision of new investor services. For example, stored information which can be shared with:

- issuers (e.g. in respect of investor elections to participate in DRPs or bank account details for the payments of dividends), to better support investor participation in, and the processing of, corporate actions; and
- settlement participants (e.g. in respect of information for a holder / client), could better support portability of CHESS holdings.

Stakeholder input

The Data Storage, Delivery and Reporting Working Group requested ASX to investigate the feasibility of a centralised depository for the capture and storage of static end investor data and to distribute certain data to permissioned users. This was on the basis that it will assist in reducing the costs associated with the duplication of the capture and storage of some of this data and reduce the operational cost of client on-boarding. This new feature was also validated in roundtables held with issuers in February 2018.

Regulatory considerations

Amendments to the ASX Settlement Operating Rules will support this requirement.

Refer also to regulatory considerations for the above requirement for account information - additional investor information (Section 2.2.2).

2.2.4 Account information – Standardised registration details

The new system will support the standardisation of the format for holder registration details and the planned investor details recorded on the CHESS sub-register⁹.

ASX will work with industry to standardise the format for the provision and maintenance of holder registration details and the planned investor details entered by settlement participants, issuers' share registries and clearing and settlement (CS) facilities. For example, this includes standardisation in relation to:

- the entry of names (e.g. full middle name vs initial only); and
- abbreviations (e.g. 'Pty Ltd' v 'Pty Limited' v 'P/L' v 'Proprietary Limited', or 'Ave' v 'Av').

The standardisation will leverage off existing standards frameworks, e.g. Australia Post address presentation standards. It will also seek to accommodate changes to requirements specified by regulators, e.g. to facilitate new ATO specifications for SMSFs which allow for up to 4 individual trustees for the holding of assets (increased from 3 previously).

The standardised format will adhere, to the extent relevant, to industry global messaging standards, such as ISO 20022.

Rationale

A standardised format for the recording of holder registration details will assist in avoiding instances where two or more holdings are created in respect of the same holder, but where the registration details are

⁹ Refer also to Section 8.3 in connection with the use of ISO 20022 messages which expands the current 180 character limit and separates name and address into distinct fields (avoiding current arbitrary abbreviations).

recorded slightly differently, e.g. if recorded by one settlement participant as Mr John S Smith and by another as Mr John Samuel Smith.

In relation to the requirement to generate client CINs, this change will also assist in avoiding instances where separate CINs are created for the same client due to slightly different registration details being provided by settlement participants.

It will also facilitate more accurate identification of relevant holdings in response to requests for information, e.g. regulator notices or court issued subpoenas to identify shareholdings of a person.

Stakeholder input

The Transfers and Conversions Working Group requested there be a standardised format for the recording of holder registration details. This was on the basis that it will assist in reducing operational inefficiency and cost associated with managing the holdings of a client that has different holding registration details entered for their respective CHESS holdings and/or issuer sponsored holdings.

The standardisation of the format for the recording of holder and investor registration details will require the active engagement and adequate resourcing from settlement participants and share registries acting on behalf of issuers to:

- map out the holder and investor registration details where standardisation is required;
- agree on the format for standardisation;
- enter and maintain registration details in a manner which aligns with the agreed standard; and
- transition existing holder registration details to the new standardised format.

Regulatory considerations

As indicated above, the standardised format will need to accommodate changes to requirements specified by regulators, e.g. up to 4 individual trustees for SMSFs (increased from 3).

Consideration will be given to any relevant Australian and international standards frameworks that can assist in developing this requirement.

2.2.5 Pre-settlement – Settlement lock for CHESS holdings

The new system will give settlement participants the option to place a 'lock' on, or commit, financial products held in a client CHESS holding for delivery into its settlement account on the settlement day the financial products are due. To place financial products in a 'lock', the settlement participant will need to send a 'commitment/lock' instruction to ASX Settlement between the relevant trade date (T) and prior to the batch cut-off time on the scheduled settlement day. This will be generally be prior to 11.30 am on trade date plus two business days (T+2).

ASX Settlement will validate that the relevant securities are available and are locked for settlement.

The settlement participant will continue to be required to include the consideration value for the sale of those financial products - client trust receivable amount, in messages sent to 'lock' those financial products. The client trust receivable amount will continue to be required to be paid into its client trust account at the same time as batch settlement occurs.

The delivery of 'locked' financial products into the settlement participant's settlement account will not apply in the case of a suspension of the participant following an event of default. It may also not apply if, following an event of default, ASX Settlement has continued to allow the settlement participant to participate in the

settlement facility but only for limited purposes, e.g. for facilitating transfers of holdings to a new sponsoring participant.

For all client CHES holdings to be used in batch settlement in connection with a sale transaction executed on, or reported to, an AMO, it will be required that those financial products be delivered directly into the participant's settlement account. This will remove the accumulation account staging process for client CHES holdings currently undertaken in the lead up to settlement.

Rationale

The use of the settlement lock for securities subject to delivery in settlement will increase settlement certainty for those transactions. It will also reduce the number of transactions being moved through the accumulation accounts of settlement participants and, as such, reduce and simplify the daily reconciliation of those accounts.

The delivery of securities directly from a client CHES holding to the participant's settlement account at settlement will provide additional protection for investors as the client remains on the register with legal title over the securities for the period up to the commencement of the batch process.

This requirement will be implemented notwithstanding that the provision of a margin offset for clearing participants using the settlement lock may not be available. The reasons why the margin offset may not be available include:

- the financial products subject to the lock not being available in the circumstances of a default (as indicated above); and
- the calculation and calling of cash market margin on a portfolio basis (including the current use of correlation margining) means that the exclusion of positions with a settlement lock (sell side) from netting calculations will more likely result in a margin increase because of an asymmetric portfolio.

Stakeholder input

The Settlement Enhancements Working Group supported the requirement on the basis that it will provide for increased settlement certainty and process efficiency, reduce accumulation entrapment account reconciliation, and improve investor protection against a participant default during the settlement period.

Regulatory considerations

Amendments to the ASX Settlement Operating Rules will support the process for placing a 'lock' on, or committing, financial products held in the client CHES holding for delivery into the settlement participant's settlement account.

Amendments to the ASX Settlement Operating Rules will also remove the ability for a settlement participant to transfer financial products from a CHES holding to its settlement account via its accumulation account for settlement of a sale transaction.

Single cash market account v client segregation

The Reserve Bank of Australia's Financial Stability Standards and the Principles for Financial Market Infrastructures require a central counterparty to have rules and procedures that enable the segregation of a participant's customers' positions, and collateral provided to the central counterparty and to employ an

account structure that enables it readily to identify positions of a participant's customers and to segregate related collateral from those of the participant.¹⁰

ASX Clear currently does not offer segregation of client margin for cash market transactions – it only offers a single cash market account (comingled house and client positions) with net margin funded by the participant. ASX's current arrangements offer materially equivalent – but not identical – protections to those afforded by segregated house/client omnibus accounts.¹¹ One of the features of the current arrangements is that client collateral is segregated and held in trust at the clearing participants; this means that clearing participants have to fund all cash market margin held at ASX Clear.

The new system will have functionality that can be configured to support segregation of participant's customers' positions and collateral from those of the participant during the pre-settlement period. Consequently, once the new system has been implemented there will be scope for Regulators to revisit client segregation and consider alternative account structures. Although no changes are being made to the current account structure as part of Day 1 functionality, at some time in the future participant feedback will be sought by ASX to inform further analysis on alternative account structures¹².

2.2.6 Pre-settlement – Settlement lock for issuer sponsored holdings

The new system will allow an issuer's share registry to 'lock' issuer sponsored financial products scheduled for delivery in settlement and deliver those financial products into the settlement participant's settlement account on the settlement day. It is expected that the arrangements for such a 'lock' will be similar to those being planned for CHESS holdings as referred to in Section 2.2.5.

Rationale

The use of the settlement lock for securities subject to delivery in settlement will increase settlement certainty for those transactions. It will also reduce the number of transactions being moved through the accumulation accounts of settlement participants and, as such, reduce and simplify the daily reconciliation of those accounts.

The delivery of securities directly from a client issuer sponsored holding to the settlement participant's settlement account at settlement will provide additional protection for investors as the client remains on the register with legal title over the securities for longer throughout the settlement period.

ASX will proceed with this requirement notwithstanding that the provision of a margin offset for clearing participants may not be available. The reasons why the margin offset might not be available include:

- the financial products subject to the lock not being available in the circumstances of a default; and
- the calculation and calling of cash market margin on a portfolio basis (including the use of correlation margining) means that the exclusion of positions with a settlement lock (sell side) from netting calculations will more likely result in a margin increase because of an asymmetric portfolio.

¹⁰ Standard 13.2 of the Financial Stability Standards for Central Counterparties.

¹¹ The assessment of material equivalence was conducted by RBA having regard to the Guidance under Standard 13.2.10 which provides that under certain circumstances central counterparties may be able to achieve materially equivalent protection of customer assets by alternative means. For details of the current arrangements see Section 3.6.2 of the RBA's 2013/14 *Assessment of ASX Clearing and Settlement Facilities*, available <http://www.rba.gov.au/payments-and-infrastructure/financial-market-infrastructure/clearing-and-settlement-facilities/assessments/2013-2014/pdf/report-2013-2014.pdf>.

¹² For further details on possible account structures see the 2013 ASX consultation paper, *Financial Stability Standards Implementation: The Way Forward*, available here: <https://www.asx.com.au/documents/clearing/financial-stability-standards-implementation-consultation-paper.pdf>.

Stakeholder input

The Settlement Enhancements Working Group supported the requirement on the basis that it will provide for increased settlement certainty and settlement process efficiency, reduce accumulation entrapment account reconciliation, and improve investor protection against a participant default during the settlement period.

ASX will conduct further consultation with stakeholders to establish the detailed design of this functionality.

Regulatory considerations

This requirement will be subject to maintaining an outcome that a settlement participant pays into its client trust account the consideration value for the sale of financial products held in issuer sponsored holdings - client trust receivable amount, at the same time as batch settlement occurs.

Currently for client financial products in a CHESS holding or a settlement participant's accumulation account, this outcome is supported by settlement participants being required to include the client trust receivable amount in instructions sent to ASX Settlement for the delivery of such financial products into its settlement account. A similar mechanism will need to apply where those financial products are delivered to the settlement participant's settlement account directly from issuer sponsored holdings.

The delivery of securities directly from issuer sponsored holdings into a settlement participant's settlement account at the same time as the commencement of batch settlement also raises additional settlement risk considerations due to:

- ASX Settlement not having oversight or control over issuer sponsored holdings; and
- the reliance on issuers' share registries for the delivery of securities during batch settlement.

These additional settlement risks could lead to greater delivery fails if, for example, the issuer's share registry does not have sufficient controls in place to ensure the preservation of 'locked' financial products for delivery into settlement or otherwise due to system interface issues between the systems of an issuer's share registry and ASX Settlement which prevent the transfer of the financial products for settlement.

Further consideration needs to be given to any additional risks that arise under this requirement and any changes required to the regulatory framework to support it.

2.2.7 Pre-settlement – Bilateral transaction matching

The new system will allow settlement participants on both sides of a bilateral transaction to pre-match the transaction earlier in the settlement period without committing the transaction for settlement. This functionality will allow a settlement participant to confirm a transaction is matched prior to the settlement day.

This requirement will effectively introduce a new 'status' or stage for a bilateral transaction of 'pre-matched' prior to it being 'matched' for those that wish to utilise this service enhancement. It will allow a settlement participant that has not received a settlement instruction from their client to send the details of the proposed bilateral transaction to the other party to confirm all other matching criteria. Once the participant had received the client instruction to proceed with settlement, the participant will send a message confirming that the transaction was 'matched'. Those settlement participants that want to go straight to 'matched' will still be able to do so. If either side of the transaction was still in a 'pre-matched' status by the commencement of the daily batch process, the transaction will not settle. This is consistent with what currently happens if a party has not received settlement instructions from their client prior to the commencement of the batch.

There will also be an additional reference field with mandatory matching criteria to better facilitate settlement of stock borrowing and lending transactions.

ASX will review the tolerance models for settlement value matching criteria for bilateral transactions with interested stakeholders. Consideration is being given to potentially providing larger tolerance windows and the opportunity for bespoke tolerance levels (which will be masked from the other party). Currently, there are three tolerance thresholds used: a \$1 tolerance limit for transactions valued at less than \$500,000.00; a \$10 tolerance limit for transactions valued between \$500,000.01 and \$999,999.99; and a \$20 tolerance limit for transactions valued at \$1,000,000.00 and above.

Rationale

The bilateral transaction matching service enhancements will increase efficiency and certainty in the settlement matching process in the lead up to settlement for participants. More broadly, ASX expects this to lead to a reduction in settlement failures in bilateral transactions.

Stakeholder input

The Settlement Enhancements Working Group requested that ASX consider introducing pre-matching functionality and optional additional matching criteria on the basis that it will allow for errors (mismatches in counterparty, and transaction value and basis) to be identified and corrected earlier in the settlement period.

In further discussions with industry, the additional matching criteria ASX was requested to introduce was limited to mandatory matching criteria for stock lending and borrowing scenarios.

Regulatory considerations

These requirements will be supported by changes to the ASX Settlement Operating Rules.

2.2.8 Pre-settlement – Transfer of novated equities transactions between clearing participants

The new system allow obligations under novated equity transactions to be transferred between clearing participants on the trade execution date (T) and prior to netting which occurs on the night of T. The arrangements will be similar to those currently in place for novated exchange traded option (ETO) contracts (i.e. give-up/take-up). The ability for clearing participants to utilise such a service will be subject to their clients having clearing arrangements in place with both clearing participants. This service will not apply in the case of a suspension of the clearing participant following an event of default.

If the receiving clearing participant does not accept the transaction before the commencement of netting then the responsibility for the settlement of that transaction remains with the original clearing participant.

Rationale

The ability for novated equity transactions to be transferred between clearing participants on T will assist in avoiding market disruption associated with large transactions being cleared by smaller or mid-tier clearing participants with limited ability to manage the capital and margin requirements associated with clearing such transactions.

Stakeholder input

The Settlement Enhancements Working Group supported this requirement on the basis that it will assist institutional and high net worth retail clients transferring clearing obligations to a client nominated clearing participant. ASX has similarly received input from a few of its customers indicating that having these types of

arrangements in place will assist them in continuing to undertake the execution of large transactions and, at the same time, outsource the clearing arrangements if required at an appropriate time.

Regulatory considerations

This requirement will be supported by changes to the ASX Clear Operating Rules.

2.2.9 Pre-settlement – Additional preliminary payment notifications

The new system will provide additional calculations of preliminary net payment obligations and entitlements per participant identifier (PID) periodically prior to batch settlement (11:30am) on each settlement day and notify these to the relevant settlement participant and its payment provider.

This will reflect preliminary calculations of payment obligations and entitlements based on instructions due for settlement that day at the time the calculation is run. ASX Settlement will engage with relevant stakeholders to determine the timing that such calculations could be run, but as an example this may be configured at 9am, 9:30am, 10am, 10:30am and 11am on each settlement day.

The additional notifications under this requirement are expected to supplement existing notifications by ASX Settlement to:

- payments providers of preliminary (expected) net payment obligations and entitlements by 8am on each settlement day (on a best efforts basis); and
- settlement participants of projected net payment obligations and entitlements immediately after 11:30am on each settlement day.

Rationale

The provision to settlement participants and their payment providers of additional notifications of preliminary payment obligations and entitlements will allow them to better manage the settlement participant's funding requirements on each settlement day.

This may assist in reducing the time required by payment providers to authorise actual net payment obligations and entitlements of settlement participants during batch settlement processing, which may assist in shortening the duration of batch settlement.

Stakeholder input

The Settlement Enhancements Working Group supported this requirement on the basis that it will reduce the time payment providers require to approve batch payments and reduce the duration of daily batch settlement processing as well as allowing settlement participants greater control on their cash flow requirements.

Regulatory considerations

This requirement will be supported by changes to the ASX Settlement Operating Rules.

It is also anticipated that amendments to the Standard Payments Provider Deed between ASX Settlement and payment providers will be required. This will require the agreement of Australian Payments Network Limited.

2.2.10 Pre-settlement – Single access point to validate SRN

The system will create a single access point for settlement participants to be able to validate the securityholder reference number (SRN) for issuer sponsored holdings. To implement this requirement a

copy of the issuer sponsored register will need to be provided by issuers via their share registry to ASX on a daily basis.

Rationale

The provision of a single access point that provides settlement participants with a more effective and streamlined process for identifying and validating their clients' SRNs with respect to their issuer sponsored holdings is expected to improve efficiency in the settlement process and ultimately provide for greater settlement certainty.

Stakeholder input

The Settlement Enhancements Working Group expressed their frustration in having to use different registry portals with a narrow set of acceptable criteria to validate their clients' SRNs. These stakeholders considered that a single and more effective access point to validate their clients' SRNs will allow for a more timely confirmation of their clients' issuer sponsored holdings in preparation for settlement and that this will reduce settlement risk.

ASX will conduct further consultation with stakeholders, including issuers and their registrars, to establish the detailed design of this functionality.

Regulatory considerations

This requirement relies on the delivery by issuers via their share registry of a copy of the issuer sponsored register to ASX on a daily basis.

Further consideration of the privacy implications of the collection, use or disclosure of personal information associated with the SRN is required to support this requirement.

This requirement will be supported by changes to the ASX Settlement Operating Rules.

2.2.11 Settlement - Non-batch DvP bilateral settlement

The new system will allow settlement participants to settle bilateral transactions outside the daily batch process on a delivery vs. payment (DvP) basis using a real time payment facility. Settlement participants will have the option to take up this service on a bilateral transaction by transaction basis.

Currently, for bilateral transactions settled outside of the daily batch process, the cash component of the transaction is settled outside of CHESS, which exposes the parties to the transaction to counterparty and settlement risk.

ASX is in an early stage of evaluating platforms such as Austraclear and the New Payments Platform (NPP) that could be used for the real time payment facility that will form part of this service.

Rationale

The ability to settle bilateral transactions outside the daily batch process on a DvP basis using a real time payment facility is expected to reduce counterparty and settlement risk. This reduction in risk will be material for large bilateral transactions that need to be settled outside the batch process. It also provides the benefit of allowing settlement participants to settle bilateral transactions relating to novated settlements, but which missed batch processing deadlines (e.g. due to late settlement instructions from clients), to also settle on the same day as the settled trade (generally T+2) on a DvP basis.

Stakeholder input

The Settlement Enhancements Working Group supported the requirement on the basis that it will provide a more efficient settlement mechanism for large bilateral transactions being settled outside of batch, and it will reduce counterparty and settlement risk.

ASX has received input from stakeholders indicating that this service will be beneficial to the market and will most likely be used in the following scenarios:

- settlement of large bilateral transactions outside of the batch process;
- facilitating stock lending and borrowing transactions for brokers;
- settlement on T+2 where there are late settlement instructions from a client (i.e. missed batch on T+2); and
- time critical settlement (e.g. to become a registered holder in time to participate in corporate action events).

Regulatory considerations

This requirement will be supported by changes to the ASX Settlement Operating Rules.

Arrangements will also need to be put in place with the payment facility and payment providers to support the mechanism and provide the required legal certainty for a DvP settlement outcome.

The application to the new non-batch DvP bilateral settlement process of protections under the Payment Systems and Netting Act (PSNA) from the unwinding of performed transactions due to the insolvency of a party will also need to be considered, including if new approvals under the PSNA are required.

2.2.12 Settlement – Settlement message enhancements

The new system will allow:

- non-batch related instructions to be processed while the daily batch settlement process is underway;
- settlement participants to prioritise processing of categories of settlement messages over other categories of settlement messages; and
- settlement participants to opt out of receiving non-mandatory messages. A suite of mandatory messages will be determined in consultation with stakeholders.

Rationale

The settlement message enhancements will increase settlement efficiency and avoid tasks queuing for processing following the daily settlement cycle.

Stakeholder input

The Settlement Enhancements Working Group requested that ASX consider allowing settlement participants to prioritise key settlement messages and opt out of other messages on the basis that it will assist them in more efficiently managing their daily workflow. In respect of the request that non-batch instructions continue to be processed through the batch process, the working group indicated that the key areas where they considered it important for instructions to continue to be processed were:

- corporate action processing;
- trade registration confirmation;
- holder management (e.g. applying holder locks); and

- transfers and conversions.

Regulatory considerations

These requirements will be supported by changes to the ASX Settlement Operating Rules.

2.2.13 Settlement – Settlement in foreign currencies

The new system will provide for DvP settlement of bilateral transactions outside the daily batch process in eligible foreign currencies. Under this requirement, ASX will not provide the FX conversions required to support settlement, that is, the settlement participants will be responsible for arranging any FX transactions to ensure they have the correct amount of agreed currency for settlement. ASX will put in place arrangements for foreign currency bank accounts to support settlement of these transactions.

Consideration will also be given to leveraging Austraclear facility arrangements for foreign currency settlement.

Rationale

This enhancement to ASX's settlement service will support settlement participants seeking to settle all securities transactions transacted in the Australian market through the one clearing and settlement system even where they have clients that have requested that the cash component of a securities transaction in the Australian market be settled in a foreign currency.

Stakeholder input

The Settlement Enhancements Working Group requested that ASX consider providing the capability for bilateral transactions to be settled in foreign currencies to reduce settlement inefficiency associated with settling Australian market securities transactions through another clearing and settlement system (e.g. Euroclear or Clear Stream).

Regulatory considerations

Consideration will be given to the applicable CS facility regulatory framework with respect to the foreign currency settlement arrangements. This includes in relation to managing settlement risks where foreign currency settlement occurs in commercial bank money and a DvP outcome for such foreign currency payments and movements of securities through ASX Settlement.

ASX expects that arrangements will also need to be put in place with the provider of such foreign currency accounts or facility to support the mechanism and provide the required legal certainty for a DvP settlement outcome.

2.2.14 Settlement – Optional early settlement

The new system will provide a mechanism for optional early settlement (i.e. other than the default position of a T+2 settlement cycle). This will need to be supported by a securities lending facility and liquidity providers.

ASX is also considering capability that will allow the early settlement of locked securities where a participant is expected to have a shortfall on the day prior to the scheduled settlement of those securities.

The functionality will enable one counterparty to settle before T+2 (i.e. it will not enable both sides to a transaction to settle before T+2).

Rationale

The ability to settle transactions early will benefit individual investors by facilitating earlier payment and delivery of securities, and it will also benefit the market by reducing time-based settlement risk.

Stakeholder input

The Settlement Enhancements Working Group was generally supportive of this requirement on the basis that it could reduce counterparty and settlement risk.

ASX will conduct further consultation with stakeholders to establish the detailed design of this functionality.

Regulatory considerations

Further consideration is required in relation to:

- the applicable CS facility regulatory framework with respect to the early settlement mechanism;
- arrangements required to be put in place to support the early settlement mechanism, including in respect of the securities lending facility and liquidity facility;
- Australian financial services licence (AFSL) requirements for the early settlement mechanism;
- credit risk involved in providing securities or funding to facilitate settlement;
- default management of securities lender / liquidity providers; and
- margin impacts on the unsettled leg of a transaction.

2.2.15 Settlement – Auto-borrow

The new system will facilitate mandatory automatic borrowing by settlement participants that are to fail to deliver securities for scheduled novated settlements.

Whether a delivery shortfall arises for a settlement participant will be determined at the commencement of batch settlement (11:30am) on the scheduled settlement date. Where settlement participants have secured other borrowing services prior to commencement of settlement which avoids a delivery shortfall arising, the auto-borrow mechanism will not apply.

The auto-borrow mechanism will need to be supported by one or more securities lending facilities made available to ASX (to on-lend to the relevant settlement participant) and will be subject to availability of the relevant financial products under such securities lending arrangements (expected to be limited to ASX 300 securities). The lending by ASX of securities to settlement participants under the new functionality will also be at the discretion of ASX.

Rationale

A mechanism to facilitate the performance of security delivery obligations which would otherwise not be performed will reduce the delivery fail rate and benefit individual investors by leading to greater certainty as to the settlement of transactions on the scheduled settlement date.

Stakeholder input

ASX will conduct further consultation with stakeholders to establish the detailed design of this functionality.

Regulatory considerations

The regulatory considerations for auto-borrow are similar to those detailed for the previous requirement relating to optional early settlement.

2.2.16 Corporate actions – Electronic elections for DRPs and BSPs

The new system will provide settlement participants the ability to electronically elect to participate in dividend reinvestment plans (DRP) and bonus share plans (BSP) (on a per issuer basis) on behalf of their clients.

Electronic election is anticipated to be available for both CHES holdings (where the participant is a sponsoring participant) and issuer sponsored holdings (where the participant is a broker for a holder). This requirement contemplates allowing for multiple elections per CHES holding.

Use of this electronic election process via the holder's settlement participant will be optional. A holder can continue to manually notify election to the issuer.

There is a related requirement to standardise DRP and BSP election dates as part of Corporate Actions STP Phase 2 Project that could complement this measure. This is discussed further in Appendix 1.

Rationale

The requirement will streamline the DRP & BSP election process, including reducing the amount of paper and manual processes. It will also provide holders with additional certainty that the issuer received their election by generating a real time electronic acknowledgement of receipt.

The ability to provide for multiple elections for CHES holdings will also allow settlement participants who operate nominee accounts to provide elections and notifications separately (and on a cumulative basis) based on timing of receipt of election instructions from each client, facilitating individual elections in respect of each underlying investor.

Stakeholder input

The Corporate Actions Working Group supported this requirement on the basis that it will allow for real time electronic acknowledgement of receipt of election, multiple elections per HIN and the option for part election per holding.

Regulatory considerations

Amendments to the ASX Listing Rules (in respect of listed securities) will support the election process and outline information to be provided by issuers regarding election for DRP and BSP. Further consideration is also to be given to equivalent amendments to the ASX Operating Rules (for Warrants and AQUA products).

Amendments to ASX Settlement Operating Rules will also outline the mechanism for notifying election.

2.2.17 Corporate actions – Electronic acceptance for entitlements offers

The new system will facilitate standardised electronic acceptances by settlement participants (on behalf of holders) for entitlements in respect of holdings of financial products in an issuer.

Similar to the DRP and BSP standardised electronic election process, the electronic acceptance process for entitlements will be available for both CHES holdings (where the participant is a sponsoring participant) and issuer sponsored holdings (where the participant is a broker for a holder). This requirement also contemplates allowing for multiple acceptances per holding.

It is anticipated that the electronic acceptance process will be predominantly used for pro-rata (non-renounceable and renounceable) rights issues, including accelerated rights issues. It may also be used for share purchase plans, priority issues (non pro-rata), buy backs, option conversions, takeovers and schemes of arrangement.

Use of this electronic acceptance process via the holder's settlement participant will be optional. A holder can continue to manually notify acceptance to the issuer.

For entitlement offers requiring payment (e.g. rights issues), the availability of the new functionality will be contingent on an electronic payment process in respect of the acceptance being established as referred to in Section 2.2.18. Payment will need to be made using such electronic payment process in connection with the electronic acceptance.

Rationale

The requirement will streamline the acceptance process, including reducing the amount of paper and manual processes currently being used to facilitate acceptances of entitlements. It will also provide holders with additional certainty that the issuer received their acceptance via a real time electronic acknowledgement, including for changes and cancellations submitted electronically.

The requirement will mean that the existing electronic acceptance processing by settlement participants for CHESS holdings in respect of takeover offers, will also extend to entitlement offers.

The ability to provide for multiple acceptances for CHESS holdings will also allow settlement participants who operate nominee accounts to provide acceptances separately (and on a cumulative basis) based on timing of receipt of individual acceptance instructions from each underlying investor. This will allow settlement participants, in respect of their nominee holdings, to pass on acceptance instructions as they are received from underlying investors and not wait until they have received all investors instructions or otherwise until the end of the acceptance period.

Stakeholder input

The Corporate Actions Working Group supported this requirement on the basis that it will assist in optimising submission of instructions to the issuer's share registry, provide real time acknowledgement of receipt of elections and enable multiple elections per holding.

Regulatory considerations

Amendments to the ASX Listing Rules (in respect of listed securities) will support the acceptance process and outline information to be provided by issuers regarding acceptance of entitlement offers. Further consideration is also to be given to equivalent amendments to the ASX Operating Rules (for Warrants and AQUA products).

Amendments to ASX Settlement Operating Rules will outline the mechanism for notifying acceptance of entitlement offers.

2.2.18 Corporate actions – Electronic payment for entitlement offers

The new system will facilitate electronic payments in AUD by settlement participants (on behalf of holders) to issuers in respect of an acceptance of entitlements. ASX is at an early stage of evaluating platforms such as Austraclear and the New Payments Platform (NPP) with respect to the real time payment facility that will form part of this service.

It is anticipated that the electronic payment process will be predominantly used for pro-rata (non-renounceable and renounceable) rights issues, including accelerated rights issues. It may also be used for share purchase plans, priority issues (non pro-rata), calls and option conversions.

Use of this electronic payment process via the holder's settlement participant will be optional. A holder can continue to make payment directly to the issuer, for example, by cheque or other permissible form of payment.

Similar to the electronic acceptance process in respect of entitlements, it is expected that the electronic payment process for entitlements will be available for both CHESSE holdings (where the participant is a sponsoring participant) and issuer sponsored holdings (where the participant is a broker for a holder).

This requirement also contemplates allowing for multiple payments per holding. In scenarios such as scale-back and rounding of entitlement offers, where payments may exceed actual application moneys received by an issuer from a corporate action, refunds to holders are envisaged to be paid directly by the issuer to the holder and not back to the settlement participant from whom application moneys were received.

The availability of the new functionality will be contingent on an electronic acceptance process for the entitlement offer which the payment relates to being established as referred to in Section 2.2.17.

Acceptance will need to be made using such electronic process in connection with the electronic payment.

Rationale

The requirement will streamline the acceptance process and will provide holders with additional certainty that the issuer has received payment by facilitating real time electronic acknowledgment. This will also allow payments made to issuers, which currently take place outside the CHESSE system, to take place within the new system.

The ability to provide for multiple payments for CHESSE holdings will also allow settlement participants who operate nominee accounts to make payments separately (and on a cumulative basis) based on timing of receipt of individual acceptance and entitlement payment instructions from each investor.

Stakeholder input

The Corporate Actions Working Group supported this requirement on the basis that it will assist to improve and standardise the process for electronic payments to the issuer and allow for consistent electronic confirmation of payment or notification of failures. It will also allow for acceptance and payment instructions to be sent separately.

Regulatory considerations

Amendments to the ASX Listing Rules (in respect of listed securities) will support the payment process and outline information to be provided by issuers regarding acceptance of entitlement offers. Further consideration is also to be given to equivalent amendments to the ASX Operating Rules (for Warrants and AQUA products).

Amendments to ASX Settlement Operating Rules will also be required to outline the mechanism for making payment.

ASX expects that arrangements will also need to be put in place with the payment facility and payment providers to support the mechanism and provide the required legal certainty for a settlement outcome.

2.2.19 Corporate actions – Transfer of cum entitlement balance

The new system will facilitate transfers of entitlements under corporate actions without transferring the parent financial products that the corporate action relates to.

This will apply to corporate actions where cum entitlement balance (CEB) processing is currently available, i.e. dividends, interest payments, bonus issues, rights offers (renounceable and non-renounceable), off-market buy-back, return of capital and priority issues (non pro-rata).

It is expected to be predominantly used to give effect to securities lending arrangements where it is contractually agreed that corporate actions on loaned securities are for the benefit of the lender of those securities.

Rationale

The requirement will allow the benefit of a corporate action entitlement to be provided to a securities lender under ongoing securities lending arrangements without having to recall the parent securities (including where they have been on-lent by the borrower) and, if applicable, related collateral.

Avoiding such recall of securities will also remove settlement and counterparty risk exposures from the transfer of parent financial products outside batch settlement. If those securities are returned by the borrower to the lender on a cum-basis in batch (to deliver the security benefits under the corporate action), they are unable to be returned on an ex-basis during the same batch. This means that re-delivery of these securities must occur on an ex-basis post batch.

Stakeholder input

The Corporate Actions Working Group supported the requirement on the basis that it will reduce settlement risk and counterparty exposure risk.

ASX will conduct further consultation with stakeholders to establish the detailed design of this functionality.

Regulatory considerations

This requirement is expected to involve a change to the Corporations Regulations and ASX Settlement Rules which currently provide that entitlements under corporate actions (i.e. security benefits) are conferred to a person who holds or held the relevant security¹³.

This requirement also involves a change in market convention as to how entitlements under corporate actions are described in company announcements and determined (i.e. based on holding of shares on the record date).

The present establishment of a CEB register (based on registered holding balance as at end-of-day prior to ex-date) for the purpose of determining entitlements, and the ability to move securities on a cum-and-ex basis during the ex-period, can mean that entitlements are provided to persons who do not hold shares as at 7pm on the record date (provided they are recorded on the CEB register as at the record date). However, moving away from any requirement to have held shares on or about the record date is a change from the current approach for determining who is entitled to the benefit of a corporate action.

Unless the requirement to allow CEB transfers without transferring the parent financial products becomes the sole basis for determining the conferral of security benefits, the requirement will mean that there are two ways by which entitlements are determined: (1) movements of shares on cum-basis; and (2) movements of entitlements on a stand-alone basis.

Further consideration needs to be given to the transferability of each corporate action entitlement through the CS facility under ASX Settlement's CS facility licence.

Further consideration also needs to be given to any taxation implications for dividends and franking credit availability if parent financial products were not held at the time of conferral of the dividend. Discussion with the ATO will be held before progressing this requirement.

¹³ For example, refer to Corporations Regulation 7.11.39.

2.2.20 Reporting – Continuous holding balance information

The new system will allow issuers to be provided with information on CHES holding balance changes (i.e. additions to or subtractions from a CHES holding) on a contemporaneous basis. ASX will engage with stakeholders to determine the desired frequency of the updates.

This information will supplement the end of day holding information currently provided by ASX to issuers.

Rationale

The provision of additional, contemporaneous, holding balance information will facilitate issuers being able to reconcile their share register on a more frequent basis. This offers other potential benefits to issuers, including allowing a more real time understanding of changes to their share register.

Stakeholder input

The Data Storage, Delivery and Reporting Working Group supported the requirement on the basis that it will allow issuers to reconcile their share registers more frequently.

Issuers have also provided input to ASX through roundtable discussions in 2017 and 2018. Issuers expressed an interest in being able to view their entire register in ‘real time’.

Regulatory considerations

This requirement will be supported by changes to the ASX Settlement Operating Rules.

2.2.21 Reporting – Electronic provision of holding statements and notifications

The new system will allow CHES holding statements and notifications to be provided to holders in an electronic format including by email, on an opt-in basis. Where such opt-in has not occurred, CHES holding statements and notifications will continue to be provided in paper form by mailing them to the registered address of the holder.

The ability for holders to receive CHES holding statements and notifications in an electronic format will apply in all scenarios where such holding statements and notifications are generated if:

- during a month, any financial products were added to or deducted from a CHES holding;
- a holding lock is applied to or removed from a CHES holding (e.g. pursuant to a court order);
- financial products in a CHES holding are reserved in or released from a sub-position (e.g. if used as cover for options positions registered with ASX Clear or if accepted into a takeover bid); or
- there is a change to the registration details of a holder.

The process for opting-in to receive CHES holding statements by such electronic format will be performed by the sponsoring settlement participant.

The ability for ASX Settlement to provide such holding statements and notifications electronically by email will be dependent on receiving a holder’s email address, in addition to the registration details currently provided by settlement participants when establishing a CHES holding.

Rationale

The ability to elect to receive CHES holding statements and notifications electronically provides an efficient and speedier delivery method as an alternative, while continuing to allow holders to receive CHES holding statements and notifications in paper copy by post, e.g. if they don’t have access to email.

Stakeholder input

ASX has received input from issuers through roundtables conducted by ASX in early 2018 which supported this requirement.

Regulatory considerations

These requirements will be supported by changes to the ASX Settlement Operating Rules.

Further consideration will need to be given to:

- privacy implications of the collection, use or disclosure of email addresses;
- any additional fraud risk arising, including due to phishing for holder information (e.g. HIN) by scammers pretending to be ASX in connection with the receipt of holding statements or by scammers seeking to change the email address notified for delivery of CHESS holding statements and notifications; and
- whether email addresses obtained through this opt-in process should be held on a company's register of members (including under any mandated requirements as was contemplated under the Corporations Amendment (Modernisation of Members Registration) Bill 2017).

2.2.22 mFund - Real time cash settlement, 'hold' status and transfer capability

The new system will allow for:

- real time cash settlement for mFund¹⁴ applications and redemptions, using a real time payment facility (such as Austraclear or NPP) to allow cash settlement;
- 'hold' status for mFund application requests where the Product Issuer Settlement Participant (PISP)¹⁵/registry requires further information; and
- transfer capabilities between HINs within the same mFund.

Rationale

Real time cash settlement of mFund transactions will allow applications to be settled as soon as acceptance has been received from the PISP. As a result, the mFund settlement process will be more efficient for both investors and issuers.

The 'hold' status for application requests will allow the PISP to put an application on hold where further information is required depending on the specific circumstances of the investors and/or the individual fund manager's requirements. The broker is required to provide foreign tax status information for the investor to enable the issuer to comply with regulatory obligations, such as US Foreign Account Tax Compliance Act (FATCA) and Common Reporting Standard (CRS). At present, applications are being rejected where this information is not provided. The 'hold' status will allow time for the information to be added so that the applications can proceed.

Transfer capabilities between HINs will facilitate the change of legal title in events such as a change of superannuation fund trustee. This avoids the need to undertake manual processes currently occurring (e.g. moving the units off CHESS, processing the title change and then moving the units back onto CHESS) to facilitate this change, and thereby makes the process more efficient for the investor.

¹⁴ mFund is ASX's managed fund settlement service. It allows investors to settle applications and redemptions for unlisted managed funds through the daily CHESS batch settlement process and hold managed funds in a CHESS sponsored HIN, alongside their holdings in shares and other quoted products.

¹⁵ Issuers of mFunds participate in the settlement process through a PISP.

Stakeholder input

The requirements above arose from discussions with brokers, settlement participants and mFund issuers during 2017 and 2018 at mFund Roundtable Discussions and during consultation on the CHES 10 release. The requirements were raised and supported on the basis that they will improve the efficiency of mFund and the investor experience. ASX will continue to engage with stakeholders as the requirements are developed.

Regulatory considerations

These requirements will be supported by changes to the ASX Settlement Operating Rules and Procedures.

For the requirement to allow transfers between HINs, further consideration will be given to whether any modification is required to the Anti-Money Laundering and Counter-Terrorism Financing Rules Instrument 2007. These rules were amended when mFund was introduced to recognise that the customer identification procedure is carried out by the broker when there is an application for securities using mFund. Consideration will be given to whether these rules will also apply to transfers between HINs, or whether an amendment is required.

2.2.23 mFund - sharing investor details, automation of regular payments and switching between funds

The new system will allow for:

- new functionality to communicate further investor details from brokers to mFund issuers;
- automation of regular payment plans and distribution reinvestment plans; and
- enhanced functionality to enable switching between funds.

Rationale

New functionality to communicate investor details from brokers to mFund issuers will allow a richer set of information to be provided in relation to the foreign tax status of investors for FATCA and CRS reporting. At present, information is provided for individuals and superannuation funds, but further information is necessary for other entities such as companies and trusts as part of a 'day 2 reporting process'. The enhancements will allow further details to be provided through CHES, and thereby reducing the need for a day 2 process by issuers.

Regular payment plans and distribution reinvestment plans are common in the managed funds industry but quite a manual process for mFunds. The automation of these plans will make the process more efficient for both issuers and investors.

Enhanced functionality will make switching between funds easier for investors. The current process involves investors having to take multiple steps over a number of days through the redemption and application process. The enhancement is aimed at allowing a switch between funds using a single transaction.

Stakeholder input

The requirements above arose from discussions with brokers, settlement participants and mFund issuers during 2017 and 2018 at mFund roundtable discussions and during consultation on CHES 10. The requirements were raised and supported on the basis that they improve the efficiency of mFund and the investor experience.

ASX will conduct further consultation with stakeholders to establish the detailed design of this functionality.

Regulatory considerations

These requirements will be supported by changes to the ASX Settlement Operating Rules and Procedures.

For the requirement to allow switching between funds, further consideration will be given as to how existing relief from ASIC to allow electronic applications for mFunds will apply, and whether any modification to this relief will be required. In particular, consideration will be given to how the requirement that the broker give the client a Product Disclosure Statement can best be met when there is a switch between funds.

2.3. New features to be implemented separately to CHESS Replacement

The CHESS Replacement Corporate Actions Working Group and Settlement Enhancements Working Group also generated business requirements whose implementation is not contingent on the new system to replace CHESS, i.e. they relate to rule changes or functionality separate to CHESS.

ASX business requirements responding to those working groups' input are outlined in Appendix 1 (where the issue is being addressed through the Corporate Actions STP Phase 2 Project) and Appendix 2 (where it is being dealt with through ASX Business-As-Usual processes).

2.4. New features to be implemented through service releases post Day 1

This section explains for each of the additional business requirements that ASX currently plans to support in the new system through service releases post Day 1, the rationale, the feedback received from stakeholders during the working group processes, and the anticipated regulatory implications. Further risk and regulatory analysis will be required to support implementation of the specific solution that is developed for each requirement.

The delivery of these additional business requirements, including timing and order of delivery, is subject to the consultation process under this paper and any further stakeholder feedback received during and post the implementation of the new system.

The availability to users of the functionality under these requirements on the date of the relevant service release is subject to the need to address any associated risk and regulatory implications and obtaining the necessary regulatory clearances.

2.4.1 Account information – Aggregated view of holdings

ASX plans that the new system will give investors access through ASX provided functionality to an aggregated view and reporting of holdings based on an identifier or attribute allocated to each holding by leveraging off the introduction of a CIN and additional information linked to a CHESS holding. Such access could also extend to issuers and regulators.

Further information regarding a portfolio view and the relevant attributes on which it could be based is contained under the requirements for account information - Common investor number, Additional investor information and Centralised data capture and storage (Sections 2.2.1 - 2.2.3) scheduled for Day 1 of the new system.

Rationale

This requirement will provide the capability for an investor to view the portfolio of holdings in which they have an economic interest, including where financial products are held:

- directly;
- through a custodian or other nominee;
- through a trustee (e.g. for a SMSF); or
- across settlement participants and issuers.

It will also similarly allow a consolidated view of holdings by issuers and regulators based on an attribute linked to a holding, e.g. CIN.

Refer also to the rationale for the requirements for account information - Common investor number, Additional investor information and Centralised data capture and storage (Sections 2.2.1 - 2.2.3).

Stakeholder input

The Account Structures and Participant Models Working Group requested that the new system have flexibility to support and enhance the current omnibus/custody model on the basis that it will increase timely transparency of ownership and control of securities.

Regulatory considerations

Further consideration of the privacy implications of the use or disclosure of personal information associated with an aggregated view and reporting of holdings is required.

Amendments to the ASX Settlement Operating Rules will support this requirement.

2.4.2 Corporate actions – Electronic processing of dividend claims

ASX plans that the new system will have a mechanism to enable the electronic processing of dividend claims and associated franking credits between the person who received the dividend benefit and another person who was contractually entitled to that benefit.

This mechanism is being provided predominantly to give effect to securities lending arrangements such as under an AMSLA (Australian Master Securities Lending Agreement). That is, where despite the entitlement under that agreement of the lender to receive dividends on loaned securities, the relevant securities were not transferred to the lender on a cum-entitlement basis prior to the record date for the purpose of facilitating this contractual entitlement.

Rationale

The requirement will streamline the transfer of the benefit of dividend entitlements under corporate actions which might otherwise occur directly between affected parties under contractual arrangements.

Stakeholder input

The Corporate Actions Working Group requested an electronic mechanism for processing dividend claims and any associated franking credits on the basis that it will enable an electronic claim between counterparties and also enable franking credits for dividend claims to be electronically passed on.

ASX will conduct further consultation with stakeholders to establish the detailed design of this functionality.

Regulatory considerations

Further consideration will be given to whether dividends and their associated franking credits are transferable through the CS facility on a stand-alone basis. ASX Settlement's CS facility licence is on the basis that it provides services in respect of specifically identified classes of financial products under the Corporations Act (e.g. securities).

Further consideration also needs to be given to any taxation implications for dividends and franking credit availability if parent financial products were not held at the time of conferral of the dividend. Discussions with the ATO will be sought before progressing this requirement.

Amendments to the ASX Settlement Operating Rules will also be needed to support the requirement.

2.4.3 Corporate actions – Electronic proxy voting

ASX plans that the new system will provide the ability for electronic proxy voting for all relevant issuer meetings.

As part of the requirement, the record date relative to the meeting date will be standardised so that the record date will be a fixed number of business days prior to the meeting date.

The requirement also has potential to involve the extension of proxy voting to underlying beneficiaries. The extension of the mechanism to underlying beneficiaries is dependent upon the implementation of the business requirements allowing for the recording of additional investor information and centralised data capture and storage scheduled for Day 1 implementation (Section 2.2.2 and Section 2.2.3).

Rationale

The requirement will streamline proxy voting processes by enabling electronic proxy voting, reducing the amount of paper and manual processes currently being used to facilitate proxy voting.

The requirement will also standardise the record cut-off date which will ensure consistency across voting for all relevant issuer meetings and has the potential to expand the ability to vote for underlying beneficiaries.

Stakeholder input

The Corporate Actions Working Group supported this requirement on the basis that it will standardise the record cut-off date and allow beneficial holders to vote electronically.

ASX will conduct further consultation with stakeholders to establish the detailed design of this functionality.

Regulatory considerations

Further consideration needs to be given to whether changes are required to the Corporations Act to address any existing requirements for paper or signed documentation in order for a proxy appointment to be valid. Electronic authentication of the appointment of a proxy is contemplated for companies¹⁶. However, for managed investment schemes it is contemplated that the proxy is to be signed¹⁷ and (subject to the scheme's constitution) a copy of the authority under which the proxy appointment was signed is to be provided to the responsible entity of the managed investment scheme where the proxy is executed by a person other than the holder¹⁸.

Further consideration also needs to be given to whether changes are required to the Corporations Act to facilitate proxy voting by underlying beneficiaries. The Corporations Regulations contemplate that the person who is entitled to vote at a meeting is the holder (being the legal owner) of securities and provides a mechanism for determining who holds securities for the purpose of a meeting (incorporating any ASX Settlement Operating Rule requirements)¹⁹.

¹⁶ Refer to Corporations Act sections 250A, 250BA and Corporations Regulations 2G.2.01.

¹⁷ Refer to Corporations Act section 252Y.

¹⁸ Refer to Corporations Act section 252Z.

¹⁹ Refer to Corporations Regulations 7.11.37 and 7.11.38.

Amendments to the ASX Listing Rules (in respect of listed securities) to standardise the timetable aspects will be required. Further consideration is also to be given to equivalent amendments to the ASX Operating Rules (for Warrants and AQUA products).

Further consideration also needs to be given to any further operating rule amendments to support electronic proxy voting directly by holders.

2.4.4 Participant structures – Participant models for clearing and settlement services

Previous consideration²⁰ given to separating clearing and settlement functions of ASX participants identified three potential additional clearing and settlement participant structures. The first two (which complement each other) involve separating clearing and settlement functions performed in the CS facilities (i.e. the central counterparty (CCP) and settlement facility) from settlement services provided to clients. The third involves separating clearing functions performed in the CCP from settlement functions performed in the settlement facility.

Further details on these three potential additional clearing and settlement participant structures are provided below.

Clearing and settlement performed in CS facilities vs settlement to client

Operational separation - An operational separation of the clearing and settlement functions performed by participants in the CS facilities from settlement functions provided by participants to clients, with the:

- clearing participant dealing with the CCP on novated transactions and settling those transactions through the settlement facility;
- settlement participant dealing with clients, including receiving moneys from and delivering securities to clients, relating to the settlement of client transactions; and
- clearing participant and settlement participant delivering to, and receiving from, the other through the settlement process, the securities and moneys in relation to the settlement of those transactions.

Legal separation – An extension of the above structure to achieve a legal separation of the functions performed so that the clearing participant has no legal nexus with retail clients (only to the trading participant and settlement participant) and as a result the legal obligations which apply to retail client dealings do not apply to the clearing participant. This is also commonly referred to as principal to principal (P2P) clearing.

Clearing performed in CCP vs settlement performed in settlement facility

An operational separation of the clearing functions performed by a participant in the CCP from settlement functions performed by a participant in the settlement facility, so that while a clearing participant remains responsible for performing its obligations to ASX Clear as CCP, it can appoint a settlement participant to perform those obligations in the settlement facility.

As part of its further consultation in connection with this requirement, ASX will seek to validate whether the above three potential additional clearing and settlement participant structures reflect the separation of clearing, settlement and sponsorship functions contemplated by the Account Structures and Participation Models Working Group and will facilitate the outcomes sought by the working group.

²⁰ This includes through the Business Committee (and an industry working group established by the Committee) in 2014/15 as well as in response to individual approaches to ASX.

Rationale

The requirement could potentially offer greater choice of participant models, encourage new clearing and settlement service offerings and promote greater competition in the clearing and settlement of transactions.

Stakeholder input

The Account Structures and Participation Models Working Group sought to have the ability to separate the clearing, settlement and sponsorship functions for ASX participants to perform self-clearing functions (clearing and settlement), settlement only functions, clearing only functions, sponsorship only functions and trading and settlement functions (without clearing function). This was on the basis that it will enable more opportunities for participants to improve capital management capabilities, reduce onerous client account maintenance activities and reduce third party clearing concentration risk.

The P2P clearing model was also previously considered in 2014 /15 through an industry working group established by the Business Committee. In discussions with ASIC on this model at the time, ASIC required an analysis of:

- Whether any adverse outcome in retail client protections will occur under the model?
- How will such difference in outcome be addressed?
- On what legal basis will there be a severance of the relationship between the clearing participant and underlying clients of the trading participant, so that the clearing participant was not providing financial services to the retail client?

Work on this P2P initiative was discontinued following a decision by the Business Committee that there was insufficient support by industry to progress the required legal analysis and briefing to ASIC.

ASX plans to review and undertake further consultation with stakeholders on clearing and settlement participant structures, with a view to assessing the viability of alternative participant models for the provision of equity market clearing and settlement services.

Regulatory considerations

The three potential additional clearing and settlement participant structures referred to above raise various regulatory considerations, some of which overlap.

The performance by a settlement participant (that is not a trading or clearing participant) of functions in the settlement of client transactions may impact client protections. For example, the National Guarantee Fund (NGF) which provides clients with access to compensation in certain loss scenarios arising from actions of 'dealers' in connection with the ASX market (e.g. non-performance of a transactions, unauthorised transfers and participant insolvency), does not extend to actions of a settlement participant that is not an ASX trading participant or clearing participant²¹. Accordingly the ability of a client to be able to access such compensation may be adversely affected where it relies on such a settlement participant to settle its transaction or hold its moneys or securities.

Further consideration will also need to be given to the impact on trading participants, clearing participants and other settlement participants, if such potential adverse client outcomes resulted in legislative change to

²¹ Dealers is defined in Corporations Regulations 7.5.03. Refer also to Corporations Regulation 7.5.19 (for the contract guarantee and insolvent participant limbs) and Corporations Regulation 7.5.59 (for the unauthorised transfer limb).

extend NGF protections to dealings with settlement only participants and this, in turn, led to an increase in the amount required to be held by the compensation fund.

Further consideration also needs to be given to whether additional amendments are required to the Corporations Regulations to support the functions of a settlement only participant to affect settlement of a transaction. For example, the protections provided to a participant²² that allows it to continue to be legally authorised to effect settlement of a transaction following the death of the client appears to be limited to settlement undertaken by the trading participant or clearing participant for the transaction.

The reliance by a clearing participant in performing settlement, on:

- the delivery to it of client moneys or financial products from a single settlement participant rather than directly from each of the underlying clients, or
- a settlement participant performing the clearing participant's obligations in the settlement facility, creates a concentration of counterparty exposure of the clearing participant to that settlement participant for the performance of the clearing participant's functions.

It also creates a new point of settlement failures or delays and the potential for clearing participant default if the clearing participant was not sufficiently capitalised to inject the required funds at short notice to meet payment obligations and to buy or borrow financial products to meet delivery obligations in the scenario of a default of the settlement participant to perform its obligations to the clearing participant. It will also create a point of failure if the clearing participant did not maintain its capacity as settlement participant to be able to perform settlement functions on its novated transactions in the settlement facility or alternatively have a back-up settlement participant who can step in to do so at short notice. Accordingly any increased clearing and settlement risks will need to be assessed.

As part of the assessment of increased clearing and settlement risks, further consideration also needs to be given to capital that is required to be held in the participants involved in the performance of transactions. A settlement participant that is not a trading participant or a clearing participant is not currently subject to capital requirements²³. This will need to be reconsidered given the important role being performed by that settlement participant in the settlement of trades. The quantum of Settlement Bonds and Sponsorship Bonds under the ASX Settlement Operating Rules (\$500,000 each) generally required in respect of such settlement participants²⁴ will also need to be reassessed given additional exposures of the settlement facility and holders to such settlement participants.

Removal of the retail client nexus required for the P2P model will also need to overcome ASIC's broad interpretation of when a financial services licensee is taken to be dealing / arranging on behalf of the client. Changes will also be required to the ASIC Market Integrity Rules (MIRs) and the ASX Operating Rules to remove the deemed agreement between a clearing participant and retail clients provided for under those rules.

Amendments to the ASX Clear Operating Rules and the ASX Settlement Operating Rules will be required to support this requirement.

²² Under Corporations Regulation 7.11.26

²³ Note that where the settlement participant was also the trading participant for the transaction, it will be subject to net tangible asset requirements under the Market Integrity Rules resulting in it needing to hold sufficient liquid capital to meet its counterparty risk in respect of both its client and the clearing participant.

²⁴ Refer ASX Settlement Operating Rule 4.9.

2.5. Requirements not being progressed

ASX will not progress the following business requirements that were suggested by some of the members of the working groups. In making the decision to not progress these requirements, ASX carefully considered the level of priority assigned by the organisations that participated in the working groups, the expected benefits to be derived from delivering the initiative, further feedback received in industry discussions, and the level of difficulty and regulatory change required.

2.5.1 Issuer distribution of payments

The provision of a real time electronic payment process with multi-currency capability for issuer payments to entitled CHESS sponsored holders as identified by the Corporate Actions Working Group.

Rationale

Minimal benefits would be delivered by such a service as issuers' share registries already have most of the investors' bank details.

2.5.2 Pre-allotment notification for the distribution of securities

The provision of a process for the timely, accurate and standardised notification of the distribution of securities, including confirmation of the entitled allocation and allocation made, by share registries on behalf of issuers for all relevant events for all Australian listing markets.

Rationale

Minimal benefits would be delivered by such a service as issuers' share registries currently transmit allotment messages without delay and upon completion of the calculation process. Additionally, there is a requirement that is being progressed through the Corporate Actions STP Phase 2 Project that will provide transparency through the life cycle of corporate action events. This will address some of the feedback provided by the working group in this area.

2.5.3 Spin-offs involving the entitlement to securities in foreign jurisdictions

The part of this requirement which relates to the provision of a mechanism for retail clients to be able to sell securities that have been issued in a foreign jurisdiction as part of a spin-off transaction.

Rationale

Such an initiative would have a limited use and the ability to use such a mechanism to sell securities issued in a foreign jurisdiction is at the discretion of the issuer.

2.5.4 Accelerated entitlement offers

Standardising and aligning the timetables for accelerated entitlement offers with all other corporate action event types.

Rationale

This requirement is inconsistent with the underlying rationale for accelerated entitlement offers, which is to accelerate the receipt by issuers of the majority of the funds from the event to provide funding certainty and minimise exposure to market risk.

2.5.5 Linking bilateral settlements (incoming 101 to outgoing 101)

The ability to guarantee settlement of bilateral transactions by linking bilateral settlements with the option to lock the associated underlying securities.

Rationale

ASX's new service offering that will enable DvP settlement of bilateral transactions outside of batch using a real time payment facility will address this issue for bilateral transactions that do not need to be performed in batch. It is planned that this new bilateral DvP settlement service will be available from Day 1 implementation of the new system.

A requirement for bilateral instructions to be performed in batch to be able to be linked for the purposes of guaranteeing settlement would involve the prioritisation of bilateral instructions over other instructions in the settlement batch. Changes to the operation of the back-out algorithm to support this requirement could adversely impact the current prioritisation of CCP batch instructions and settlement certainty related to novated transactions.

2.5.6 Transfer of CHESS holdings between settlement participants

The removal of the requirement for a sponsoring participant to receive a client's authority prior to confirming the transfer of sponsored CHESS holdings to a new sponsoring participant.

Rationale

This requirement involves an unacceptable loss of client protections if the existing sponsoring participant transfers the client's CHESS holdings without having received the client's instructions.

ASX has also received feedback from stakeholders that they no longer sought to pursue this change having regard to such client protection considerations and internal compliance issues in processing such transfers.

2.5.7 Change of controlling participant

Providing greater flexibility in the process to change a controlling participant, including in relation to:

- a reversal option being available for bulk transfers;
- consistent rules for individual and bulk transfers;
- partial bulk transfers to be supported by contemporary means of notification and record keeping (i.e. removal of spreadsheet);
- all participants to transfer clients in a bulk fashion without processing dual entry messages;
- holdings associated with a PID or multiple HINs can be transferred to a single HIN (e.g. omnibus); and
- electronic processing where possible.

Rationale

Working group participants placed a low priority on this requirement and it received a low level of support from industry more generally. That said, ASX is planning to work with participants to improve the process where possible.

2.5.8 Exchange traded options (cash equities collateral)

Providing the ability for exchange traded options (ETO) collateral (cash equities) to be released into a participant's settlement entrepot account as an offset to the exercised (equity contract) ETO position.

Rationale

Working group participants placed a low priority on this requirement and it received a low level of support from industry more generally. In addition, any such automated transfer could impact third party security rights (e.g. a margin lender). Further information regarding the function of collateral provided in respect of

ETOs and its interaction with such third party security rights is contained in Guidance Note 11 to the ASX Clear Operating Rules.

2.6. CHESS functionality being decommissioned

There will be some business services, process flows and message models currently supported by CHESS that will be discontinued with the implementation of the new system because they are either not currently being used or they will be replaced by more contemporary functionality. The business services, process flows and message models being discontinued are set out below.

2.6.1 Business services

The existing business services currently provided in CHESS that will be discontinued are:

- Electronic trade confirmation – this functionality is not currently used.
- Securities lending service – this functionality is not used as it is currently provided. A new securities lending service may be provided in connection with a new service providing for optional early settlement.
- RTGS service – this functionality is not currently used. This service will be replaced by a new service for DvP settlement outside batch for bilateral transactions.

As indicated in Section 5.9, the current functionality of the Trade Acceptance Service will also be replaced with more contemporary functionality that will apply the same business validation and logic to all AMOs.

2.6.2 Process flows

The mFund order reversal process, which allows a PISP to reverse and subsequently reapply unit adjustments, will be discontinued. This functionality is not currently used.

2.6.3 Message models

The message models that will be discontinued with the implementation of the new system are:

- Bilateral modify settlement instruction (EIS 121 and associated messages).
- Securities transformation (EIS 421).
- Block / unblock from netting.
- Certificated transfers and conversions.
- Technical negative acknowledgement (EIS 540).
- Four mFund CHESS 10 messages. This is on the basis that they are not within the scope of SWIFT.
- Redundant fields (stamp duty, regular payment plan, PIN).
- Defunct reporting (PFD, PFH, USD, USH, FLN, RAC).

3. Adoption of ISO 20022 Messaging

ASX has committed to adopt the ISO 20022 messaging standard for the system that replaces CHESS. The new system will not support CHESS proprietary format messaging.

ASX set out its intention to adopt ISO 20022 messaging in place of CHESS messaging in its September 2016 consultation paper and committed to its adoption in March 2017. Respondents to the consultation were largely supportive of the adoption of ISO 20022 on the basis of the operational efficiencies that could be derived from the use of a global messaging standard. Stakeholders also emphasised the need for appropriate transition arrangements and sought more detailed information on ISO 20022, including how CHESS External Interface Specification (EIS) will be translated to the global standard.

In response to consultation feedback, ASX engaged experts from the SWIFT standards consultancy to assist with the CHESS to ISO 20022 detailed message mapping and development. ASX has also made information on ISO 20022, including a free eBook, available to users on its website and convened the ISO 20022 Technical Committee. The Technical Committee has provided a mechanism for ASX to consult interested parties on the proposed ISO 20022 messages and the necessary transition arrangements.

When the new system commences operation, ISO 20022 messaging will be adopted for post-trade messages and trade related messages, such as trade reporting, will be in the FIX format. This is on the basis that the FIX protocol is more commonly used in trade messaging. The new post-trade messages in ISO 20022 format will map to a sub-set of current CHESS EIS messages (as there will be a rationalisation of CHESS messages) and will also apply to any changed or new business functionality.

Over at least the next 12 months, ASX, in consultation with the Technical Committee will be focused on refining the proposed message set based on the functional scope of the new system and the development of documentation covering message guidelines, message maintenance and standards for message change requests and release management. ASX will also initiate a formal process with ISO for the registration of any non-standard post-trade messages and message extensions.

3.1. Mapping CHESS Messages to ISO 20022 Messages

ASX commenced detailed work regarding the adoption of ISO 20022 in 2016. ASX has engaged SWIFT, as the registration authority for ISO 20022, to assist with the adoption of the message standard and obtain input on the learnings from other similar projects including, T2S in Europe, the NPP in Australia and other market infrastructure projects undertaken in the Asian region. ASX engaged SWIFT standards consultants from September 2016 through to March 2018 to undertake a high level gap analysis between CHESS EIS and ISO 20022, followed by detailed mapping of current CHESS EIS ('as-is') to ISO 20022.

3.1.1 High Level Gap Analysis

The high level gap analysis of CHESS EIS to ISO 20022 messaging undertaken by SWIFT covered the following scope of 533 CHESS EIS messages across 13 CHESS business areas:

CHESS Business Area scope	# CHESS messages
Holder Management	57
Holding Movement	63
Clearing and Settlement	80
Collateral Management	68
Takeover	22

CHES Business Area scope	# CHES messages
mFund	85
Miscellaneous	6
Operations Admin	7
Reporting	43
RTGS Settlement	28
Electronic Trade Confirmation	30
Stock Lending	12
Tri Party Collateral	32
Total	533

The high level gap analysis provided the basis for ASX to understand which CHES messages perform similar functions or are potentially redundant. The gap analysis also identified any material impacts of the adoption of ISO 20022 that will, for example, necessitate a change in business processes at a message level. This analysis has also informed ASX's considerations regarding the management of the transition to ISO 20022.

The key findings from the high level gap analysis included:

- 533 CHES EIS messages were mapped to 120 unique ISO 20022 messages. A number of opportunities across the existing CHES message set were identified for rationalisation on the basis that a number of messages performed similar functions, noting that decisions on message rationalisation also need to consider that certain messages may have more than one use.
- 12 relevant ISO business areas were identified compared to 13 in scope CHES business areas: securities trade, securities clearing, securities settlement, securities management, securities event, collateral management, account management, reference data, cash management, payment clearing and settlement, administration, and authority.
- The breakdown of the 120 unique ISO 20022 messages identified for use by the new system relate to:
 - 60 existing ISO messages;
 - 28 new messages already developed by the T2S project in Europe identified as good candidates for further mapping (it is noted that the T2S messages are not yet registered with ISO); and
 - 32 existing CHES EIS messages across a range of business areas identified as potentially requiring new message development (i.e. the CHES EIS message didn't map well to existing ISO 20022 messages).

3.1.2 Detailed message mapping

From December 2016 to March 2018, ASX and SWIFT standard consultants undertook detailed mapping of 451 CHES EIS messages to ISO 20022 on an 'as-is' basis. Messages relating to securities lending, electronic trade confirmation, certificated securities, and a mix of ad hoc messages and reports were de-scoped from this process on the basis that they related to services that were not post-trade or were duplicate and/or redundant messages or services.

The table below sets out the number of individual CHES EIS messages mapped to equivalent ISO 20022 business lines and messages.

ISO 20022 business lines	# ISO unique base messages*	Equivalent # individual EIS messages
Account management (acmt)	3	11
Administration (admi)	3	40
Authorisation (auth)	4	21
Cash management (camt)	15	48
Collateral management (colr)	2	4
Collateral transfer (colt)	2	14
Reference data (reda)	12	36
Securities clearing (secl)	2	6
Securities events (seev)	1	2
Securities management (semt)	14	115
Securities Settlement (sese)	10	131
Securities trade (setr)	10	24
Business Application Header (head)	1	ALL
TOTAL	79	452

* including new messages

ASX considers that the detailed mapping undertaken to date on an 'as-is' basis forms a good basis for ASX in consultation with users to finalise the new ISO messages aligned to the Day 1 functional scope of the new system.

In consultation with the Technical Committee, ASX's approach to the transition to ISO 20022 messaging incorporates, to the extent possible, the following best practice principles:

- adopt ISO 20022 business model concepts and a standard message for common functions;
- define base message components which are consistently applied throughout all messages (otherwise known as usage guidelines);
- use ISO standard reference identifiers where possible;
- simplify the reporting model;
- avoid going 'live' with unregistered or draft new ISO 20022 messages. ASX has already advised the Technical Committee that in order to meet the Day 1 scope requirements for a subset of functions it will be necessary to create and seek registration of new ISO 20022 messages, and seek changes to existing messages. ASX will consider and execute this process carefully to minimise impact during and after the project delivery;
- ensure a 'freeze' of the ISO 20022 message versions during the implementation and testing phase. ASX has determined that it will use Standards Release 2017 as the version for the definition of the ISO 20022 messages for development through to go live production. As ASX is adopting a global standard, the new system and the defined ISO 20022 messages will need to be reviewed and potentially updated to accommodate annual standards releases, to ensure the latest version of the standard is employed. The timing for these releases is November in each year. This approach matches industry convention, and is currently employed via set service releases by ASX's Austraclear platform for its ISO 15022 messaging. ASX therefore expects that it will at the least require a post go live release of ISO 20022 message changes

in order to catch up to the latest version compared to the 2017 standards release base used during development;

- include market consultation and training during the lead-up to implementation. ASX will work with the Technical Committee and proposed additional working groups on the adoption of ISO 20022. This work is significant and ASX expects to provide comprehensive education and training in association with the work of those groups; and
- publish ISO 20022 usage information, including usage guidelines in a central repository, such as, the SWIFT MyStandards tool. This tool has been in use for a number of years by ASX to manage and publish its existing ISO suites of usage guidelines (e.g. Austraclear, Corporate Action notifications) for customer information. The tool has also been used for the sharing of draft ISO 20022 messages with the Technical Committee and in the future, other stakeholders, complimentary to other technical and reference documentation. MyStandards also provides 'readiness' testing functionality for customers to test their built messages for valid format prior to the availability of functional testing.

A number of the principles mentioned above are also reinforced in the Market Infrastructure ISO 20022 Harmonisation Principles that ASX has endorsed.

3.2. Approach to Transition

ASX will decommission CHESSE messaging immediately after migration to the new system and will not offer a protocol translation service. ASX will not provide backward compatibility of the ISO 20022 message set and associated processes compared to the CHESSE EIS messages due to the significant cost, data, operational complexity and risk of supporting both message formats. This does not preclude others from providing such a service. Further information is provided in Chapter 5 (Technical Solution for the CHESSE Replacement System) and Chapter 8 (Migration and Implementation Approach) regarding how ASX will manage the transition to minimise any risks associated with this change.

4. Non-Functional and Technical Requirements

A high-level overview of ASX's non-functional and other key technical requirements for the new system are set out below. The non-functional requirements have been defined by reference to:

- current CHES non-functional requirements,
- industry standards and relevant regulatory standards for financial market infrastructure, and
- estimated throughput and capacity thresholds required to support continued growth in the Australian equities market.

4.1. Availability and Resilience

ASX will require that the new system meets high availability standards, targeting the new system to be reliably available 99.95% of the time during published operating hours²⁵. This exceeds the current CHES target of 99.8% availability during published operating hours.

While target operating hours for business and transaction services have not been finalised, ASX will keep technical interface channels open for, as close as practically possible, 24 hours per day.

ASX will require that, in the absence of hardware or network component failure, the new system is stable and performance will not significantly degrade over time.

ASX will require that the new system is resilient to a single hardware component or network path failure. This requires a design that has no single point of failure for any component at either the primary or backup site.

4.2. Recoverability

ASX will require that, where possible, there will be automated failover and recovery resulting from a single component failure at the primary site.

ASX will require that the new system is recoverable without data loss to the backup site within a maximum time of one hour where there has been a serious failure, such as complete loss of a site.

In accordance with current ASX practices, the new system will be subject to regular live testing at the backup site.

4.3. Transactionality

ASX will require that the new system is transactional with respect to applying user instructions to changing the system state. In other words, instructions are applied once only, even in the event of failure and required recovery midway through processing.

4.4. Performance

A key metric that drives the majority of overall transaction processing volumes for a clearing and settlement system is the number of daily market trades.

ASX will require the new system to have a minimum of 100% capacity headroom on the current CHES production peak volume. This currently equates to the need to handle approximately 5.4 million trades per day and the associated T+2 clearing and settlement lifecycle. However, to allow for growth in trade volumes

²⁵ This is calculated using existing ASX methodology for reporting against the Financial Stability Standards (FSS).

during the implementation phase, the initial implementation will be tested to 10 million trades per day. This corresponds to a sustained rate of at least 463 trades per second during market hours.

Performance testing will encompass the full T+2 clearing and settlement lifecycle, including being able to handle all transaction processing loads, messaging to and from stakeholders, reporting, and maximum durations for netting and settlement.

The performance requirements and characteristics of each user integration channel will vary based on the expected volumes, the nature of the channel, and the user's infrastructure. The precise characteristics of each channel will not be known until they have been developed and performance tested. Users will have the opportunity to validate the performance of their integration channel as part of load testing in the industry wide testing environment.

4.5. Scalability

ASX will require the system to be scalable to ensure that it supports the processing associated with increases in daily market trading and/or other changes, including the number of users connecting to the DLT-based system using a node.

4.6. Security

ASX will require that all integration channels between ASX and users will be protected by strong authentication and encryption. Users will only ever receive data that they are entitled to receive.

The new system will be subject to further third party security review prior to the implementation of the DLT-based system. This is in addition to the two third party security reviews of DA's DLT-based platform in the second half of 2017.

4.7. Provision of Customer Test Facilities

ASX will provide customer test environments that facilitate:

- testing of all externally available system functionality;
- integration with AMO test beds so a matched trade will flow into the clearing and settlement system (i.e. an "end-to-end" environment);
- multilateral test cases with real counterparties or emulation of counterparties with simulators;
- testing against realistic production masked data sets and data volumes;
- testing of corporate actions; and
- testing of migration and implementation

4.8. Connectivity and Messaging

The new system will support both direct DLT and traditional message based integrations. This will allow users to either continue to connect and transact through messaging in a similar way as today or leverage access to the ledger and its real time data to varying degrees with DLT integration.

Both the traditional message based and the DLT integration channels will present ISO 20022 interfaces.

In response to feedback, ASX is considering requiring the system to be able to disable the distribution of messages of a particular type to a particular user where they do not want to receive them. ASX is considering the suite of mandatory messages that need to be received by users commensurate with regulatory requirements and those that particular users could opt-out of receiving.

In response to feedback on message priority and performance, the new system will provide demand reporting via an out of band channel (such as an API) so that the system can provide unrestricted access to reporting without conflicting with transaction messaging and processing.

The new system will also provide a secure browser based interface to cater to lower volume stakeholders and as a backup way of submitting transactions.

4.9. Data Access

The new system will provide methods for a permissioned user to request and access data they are entitled to access on demand.

4.10. Other requirements

ASX also has a range of other non-functional requirements including:

- monitoring, alerting and logging incidents;
- delivery of operational and support procedures and documentation;
- support for automated test frameworks;
- enterprise support for all layered products that make up the solution; and
- ensuring the system is fully compliant with ASX audit and other regulatory obligations.

5. Technical Solution for the CHES Replacement System

5.1. Introduction

The new system is built on a permissioned distributed ledger whereby all users that participate directly with a node are subject to an on-boarding process governed and managed by ASX.

Authorised users will have the choice of whether to participate directly with a node in the distributed ledger. Such access is not mandatory and some users will continue to use standard message based connections to the new system (albeit in the new ISO 20022 format, or for AMOs, FIX message format).

User nodes are expected to be offered as a managed service by ASX. This will allow users to access the benefits of a node without the overhead of day to day management and support.

While permissioned users may initiate transactions, only ASX has the authority to commit transactions to the ledger.

By operating a permissioned distributed ledger with segregated data stores and a single committer node, ASX is able to offer all the benefits of mutualised workflow and data without sacrificing privacy and performance.

The architecture, features and methods for direct integration via user nodes are explained in Chapter 6 (Digital Asset Platform and Node Access).

Access to entitled data will be made available via a Data API. This is expected to become the primary method for delivery of demand reporting. Users that have a node will also have access to real time data and can utilise that either instead of, or in conjunction, with the Data API.

This structure is set out in the following solution context diagram.

CHES Replacement Context Diagram

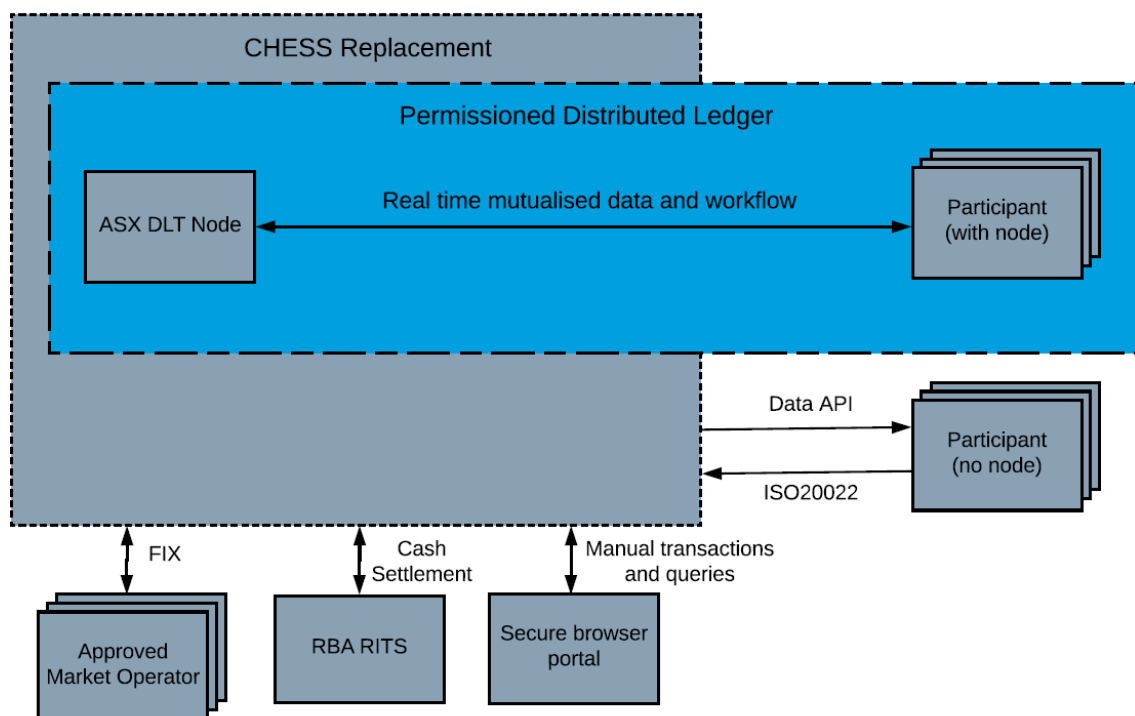

5.2. ISO 20022 Interfaces

ISO 20022 interfaces will be offered by both the direct node integration channel and traditional messaging channels.

For direct node users, there are two integration options as follows:

- ISO 20022 integration - Users may maintain their existing systems by connecting with standard XML ISO 20022 messaging, as well as receiving on-demand access to data.
- Custom integration - Users may choose to perform a deeper integration by utilising defined Digital Asset Modelling Language (DAML) workflows and bypassing XML messaging entirely.

More information on this can be found in Chapter 6.

For traditional messaging users, ASX may provide multiple options, subject to there being sufficient demand from users. The options currently being considered are ISO 20022 messaging over an open standards based interface such as AMQP or REST API; and SWIFTNet InterAct.

5.3. RBA RITS Interface

The existing interface to the RBA RITS system for net batch cash settlement is not expected to change.

5.4. Browser Interface

ASX will provide a secure browser based interface. This will replace the existing ASX supplied software called CHES PC and provide a platform for new browser based services.

The browser interface will be a:

- primary method for submitting ISO 20022 transactions for low volume stakeholders;
- backup method for submitting ISO 20022 transactions; and
- complementary method of submitting ISO 20022 transactions (e.g. submitting rare messages that have not been implemented in the stakeholders core system).

It will consist of a secure forms-based browser interface that will support:

- individual user authentication and authorisation, and mapping to the underlying stakeholder entity;
- manual creation and submission of transactions;
- the ability to review transaction status;
- monitoring and reporting;
- transaction file upload/download facility (this will be a manual facility designed for ad-hoc use only); and
- the potential to add value added workflow for specific use cases

5.5. Data API

On-demand access to entitled data will be provided through a secure API. This is separate to the real time data access that users with a node will have access to. However, users connecting via a node will not be excluded from also using the Data API.

This will be a modern, secure API provisioned through a fully featured API management platform to facilitate:

- delivery of demand reporting through a non-messaging channel;

- provision of new services such as a view of current net cash obligations to payment providers;
- access to data to assist with the migration and implementation phase; and
- in conjunction with an ability to disable receipt of specific message types, a way to retrieve data on trade registrations and results of netting outside of the traditional messaging channel and on-demand.

For retrieval of large amounts of data, the API may operate in conjunction with a secure FTP portal. For example, a participant may request the API to create the data file which is then picked up from the secure directory on its sFTP server.

5.6. Networking

Access to the user nodes, non-SWIFT messaging, and the Data API will be provided over ASX Net and/or an internet Virtual Private Network (VPN). Similar to CHES today, an internet VPN may be subject to certain restrictions for some stakeholder types.

Access to the browser interface is expected to be over the internet but may be restricted to internet VPN or an otherwise more secure connection for some user types.

Access to SWIFTNet (if offered) would be through SWIFT approved network providers.

5.7. Security

The solution will make use of Digital Certificates at organisational level for authentication, encryption and signing. As part of the build phase ASX will engage with public key infrastructure (PKI) consultants to determine the most appropriate solution. Amongst other things, this will include consideration of the:

- operation of the Registration Authority and the Certificate Authority;
- processes and procedures for the whole of key lifecycle; and
- automation of key renewal.

Access to the browser interface is not expected to require certificates issued to individuals. Instead, ASX will explore alternate methods for two factor authentication that are more user friendly without compromising security.

5.8. Legacy Functions

5.8.1 Historical Data

Historical data in CHES that is normally made available through demand reporting is anticipated to be available via the Data API post migration.

5.8.2 CHES PC

The CHES PC software will be decommissioned on migration to the new system.

Users of CHES PC for manual entry of transactions will be able to use the new secure browser interface.

Users of CHES PC as a CHES message gateway should consider one of the new integration channels. Note that it will be still be possible to upload and download message files using the secure browser interface but this will be for ad-hoc manual use only.

5.8.3 CHES Access

The CHES Access software will be decommissioned on migration to the new system.

Users of CHES Access as a CHES message gateway should consider one of the new integration channels.

5.8.4 CHES Messaging

CHES Messaging, as defined in the CHES External Interface Specification, will be decommissioned on migration to the new system.

CHES messaging is being replaced with ISO 20022 based messaging.

- ASX will not offer a protocol or message translation service from CHES messaging to ISO 20022.
- Further, ASX doesn't guarantee that translation will be possible since there may be changes to some business processes that means data that is mandatory in one standard is not present in the other.
- If users intend to attempt to provide a translation service, they should contact ASX early in their project so that ASX can assist in assessing the feasibility of the service.

5.9. Access to ASX's CS Infrastructure – AMOs and other CS facilities

ASX has committed, through its Code of Practice for Cash Equities Clearing and Settlement, to provide access to its clearing and settlement infrastructure on transparent and non-discriminatory terms. In particular, it will ensure its investments in the systems and technology that support its infrastructure are not designed in such a way as to raise barriers to access to other market operators or clearing and settlement facilities.

The new system has been designed (including technology, global message standards and use of APIs) in a manner that does not create access barriers to non-affiliated market operators and clearing and settlement facilities.

5.9.1 Interface arrangements – Approved Market Operators (AMOs)

The current interface design for the reporting of trades and prices by AMOs for clearing and settlement (including under the Trade Acceptance Service (TAS)), will be replaced with a new interface that delivers messages from all AMOs in FIX format over a fit-for-purpose transport into the ASX clearing and settlement facility.

The DLT Client API and the ASX clearing and settlement facilities will perform common business validation and logic for all AMOs reporting trades for clearing and settlement. This includes in the case of the:

- DLT Client API - validation of expected message types, as to format and syntax; and
- ASX clearing and settlement facilities - validation of message contents and all other business logic associated with registration, including novation and netting eligibility.

The architecture design for the interface is represented in the diagram shown on the following page.

For non-ASX affiliated AMOs using the existing CHES PC interface for performance of functions as a settlement agent, that interface will be replaced via a browser based interface.

In line with all other CHES demand reporting, ASX also plans to provide sub-register status reporting to AMOs through the Data API interface, replacing current CHES EIS messaging.

AMOs interface for clearing and settlement – architecture

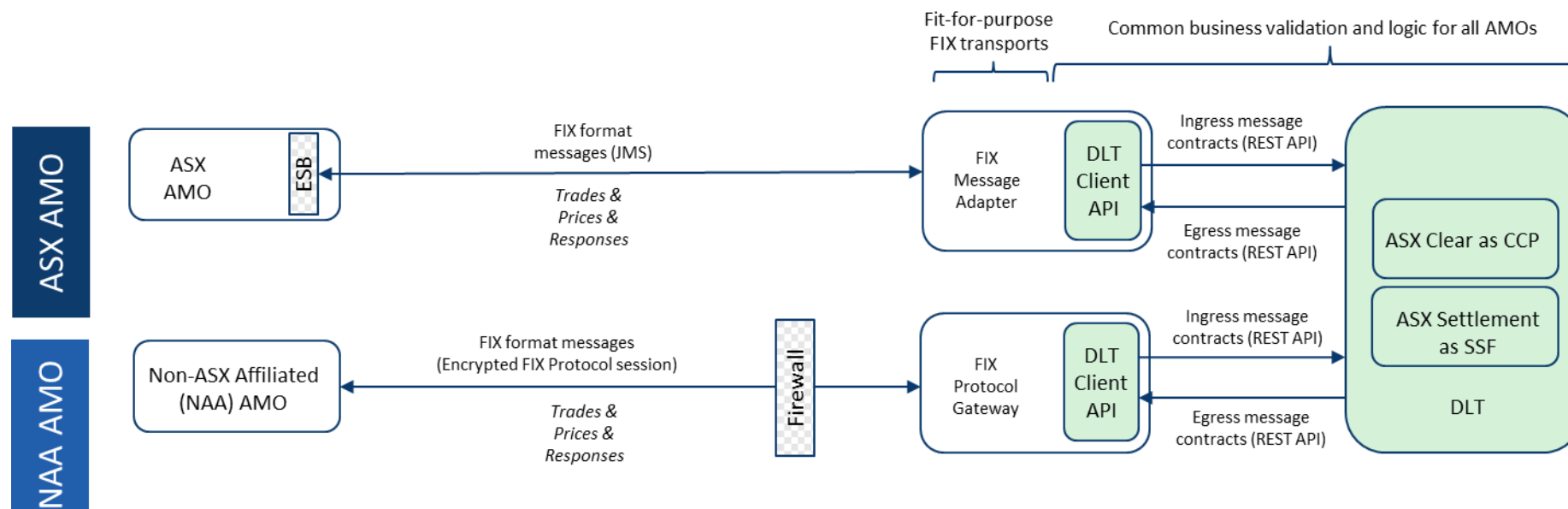

- All AMOs report trades and prices in FIX message format over a fit-for-purpose transport.
- All AMOs subject to business rule validation and logic implemented once in the DLT Client API and the ASX clearing and settlement facilities (refer LIGHT GREEN fill).
- ASX AMO trades reported from the internal ASX ESB via the FIX Message Adaptor into the DLT Client API.
- NAA AMOs report FIX messages via a FIX Protocol Gateway, secured with modern TLS encryption. Only session validation is done by the FIX Protocol Gateway.
- Access to sub-register status reporting via Data API (not shown on diagram). This will replace all CHES demand reporting.

Rationale

The design provides non-discriminatory access for all AMOs to the ASX clearing and settlement facilities and equivalent outcomes for the clearing and settlement of AMOs trades.

It meets the functional requirements for the interface in relation to clearing and settlement. This includes standardised functionality for all AMOs:

- optionality in settlement date reporting (if no date is supplied the system will determine the date) and clearing participant ID reporting (if it is not supplied the system will map the ID from the supplied trading participant ID); and
- support for message based trade registration confirmation or rejection and uninterrupted trade registration during settlement.

The interface also meets the non-functional requirements for the interface in relation to clearing and settlement. This includes: availability and resilience, recoverability, performance, scalability and security.

The fit-for-purpose FIX transport accommodates messages from non-ASX affiliated AMOs and their requirements for secure and guaranteed delivery transport (with those messages being received via a FIX protocol session and subject to a firewall and encryption). It also accommodates messages from the ASX AMO, reducing risks for ASX and its participants from additional failure points that will arise from externalising these messages.

The design also provides a low operational risk for both ASX and non-ASX AMOs for the clearing and settlement of trades. This includes through:

- re-use of generic message bus to DLT interfaces also used for ISO20022; and
- adoption of FIX format messages based on what is used for regulatory reporting by AMOs today.

The use of a browser based interface for settlement agent services will allow for provision of improved access to such services.

The use of the Data API interface for sub-register status reporting will facilitate flexible on-demand reporting and will be the same interface used for broader CHES demand reporting.

Stakeholder input

The AMO Working Group requested that all AMOs have access to the same base clearing and settlement services under the system which replaces CHES, and that the new system have the capacity to accept, register and novate (where eligible) transactions affected through AMOs for clearing and settlement.

The AMO Working Group will continue to offer a forum for AMOs to discuss issues around the nature of their access to ASX's clearing and settlement infrastructure.

5.9.2 Interface arrangements – Other clearing and settlement facilities

As the sole provider of cash equity clearing and settlement services in Australia there are currently no linkages between CHES and other facilities.

The design of the new system, particularly the use of global messaging standards and APIs, will facilitate access by other clearing and settlement facilities on non-discriminatory terms. In the absence of a specific request for access, including an indication of what services another facility may wish to offer, it is not yet possible to define the specific requirements that will support interoperability.

6. Digital Asset (DA) Platform and Node Access

As previously outlined, users have the option to maintain their existing systems by connecting to the new system with standard XML ISO 20022 messaging, and utilising on-demand access to data. Alternatively they may choose to perform a deeper integration by taking a DLT node and utilising the Digital Asset Modelling Language²⁶ (DAML) to develop integration applications, and bypass XML messaging entirely.

The DA platform combines DLT and the DAML to allow the mutualisation of workflow processing between ASX and users. The users who are operating on ASX's DA platform are able to share a single source of truth which provides continuous data integrity, increased transparency where required, and the opportunity for innovation.

The new system consists of a post-trade application, written in DAML, which interfaces with the DA platform. The DA platform processes the business logic for the cash equities market and sends this to the distributed ledger.

Users will have the opportunity to interact directly with the new system via a node. In addition, DA will offer its DAML Software Development Kit (DAML SDK) to enable users and 3rd parties to develop DAML based applications that integrate directly to a node. This will allow a real time and deeper integration into their existing processes and to create new applications that leverage the data and services they are permitted to access.

The DAML SDK was released via a developer program in a Beta version on 19 April 2018. For organisations interested in downloading the DAML SDK Developer Preview, registrations are accepted at www.daml.com.

6.1. Ledger Components

To preserve privacy and provide scalability, the DA platform breaks out its Distributed Ledger into two subcomponents: the Private Contract Store (PCS) and the Global Synchronization Log (GSL).

Each participant node in the network will have its own privately segregated PCS, which contains all validated contracts to which the user is a party. The GSL is a shared, replicated, append-only log of immutable evidences of transactions or events. The GSL guarantees notifications, integrity, and auditability of stakeholders' data stores. Whilst the GSL can be used to verify the accuracy of individual transactions, it cannot be used to reverse-engineer the contents of the transactions, which are stored in the PCS. The combination of the PCS and GSL gives each stakeholder its unique view of the distributed ledger.

Further information is contained in the Digital Asset Platform Non-Technical White Paper which can be found at <https://www.digitalasset.com/technology>.

²⁶ DAML is the language in which logic and behaviour for the DA platform are written. It easily enables market functionality to be added to extend the platform's capabilities. DAML enforces the rules of the market through software and is used to model contractual rights and obligations in executable code within the boundaries of those market rules.

6.2. CHES Replacement Components

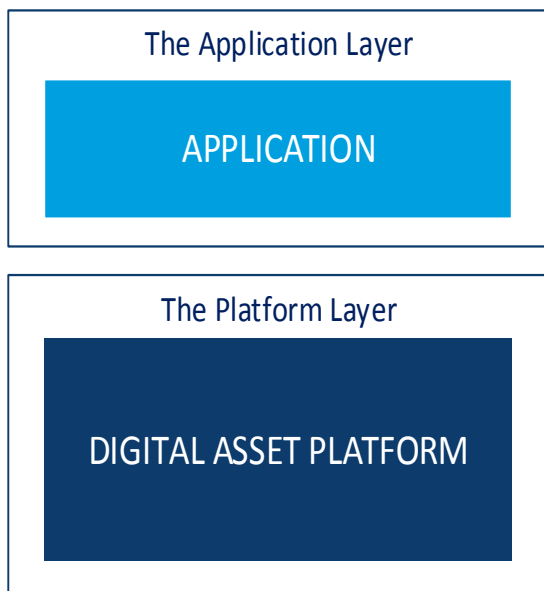

CHES replacement is comprised of two layers:

- The Application layer handles the integration between ASX and the user's existing infrastructure. It feeds commands into the DA platform and reads outbound events.
- The Platform layer is a common software stack, used by ASX and all users who take a node. It is capable of powering multiple use case specific applications. Functionality is added to the platform by loading the Cash Equities Library written in DAML.

6.3. Application Layer

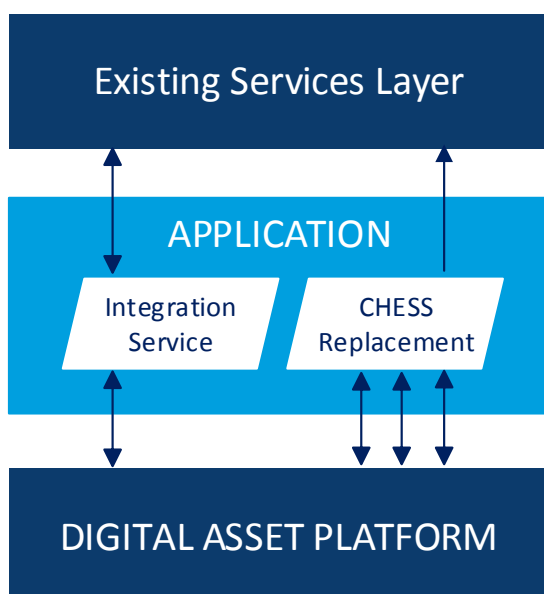

The Application layer serves two key functions:

- managing and automating business processes; and
- integrating the DA platform to a stakeholder's existing systems. These integrations may use standard messages or be bespoke.

The solution provided by DA is designed to work with existing systems with minimal impact.

Applications can both read and write to the platform and are responsible for services such as stakeholder management or trade registration. An application maintains its own 'ledger view' so that it can independently scale up to meet performance needs. In response to a handled event, an application will:

- update its ledger view;
- use its ledger view to construct a command to the platform; or
- raise a notification to external services.

6.4. Platform Layer

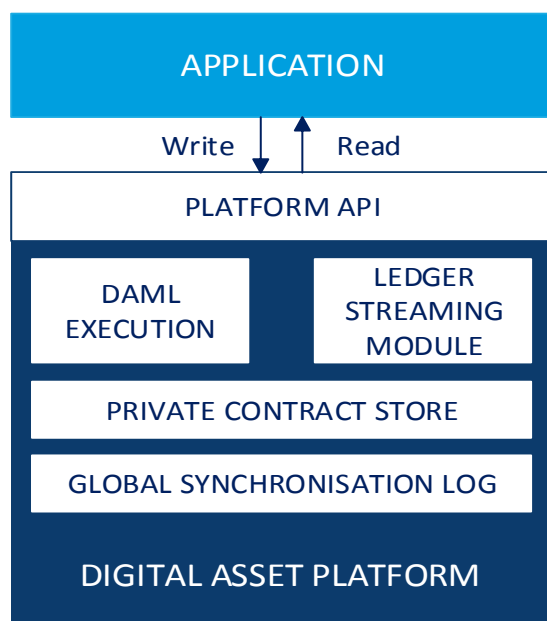

The DA platform is a common software stack, used by ASX (as the operator), and all users who are authorised and choose to take a node. Its functional behaviour is defined by the particular DAML libraries that are loaded onto the network.

The platform constructs DAML contracts, validates them against market rules, persists contracts, and distributes them.

The platform is designed with separate read and write paths to achieve better performance standards. The write path evaluates DAML models while the read path contains the Ledger Streaming Module, a cache of recent ledger data. The latter can be used to replay ledger events or query the current state of the ledger.

The software stack has been designed for horizontal scaling. For example, because the DAML execution is handled entirely on information from a contract, many instances can be run in parallel.

6.5. Nodes

A node is software that allows users to join the distributed network directly and rely on its data as a real-time, auditable source of truth.

Nodes have different configurations depending on the role of the user within the market. In the new system ASX will operate a Committer Node which has the authority to append blocks to the GSL.

Users who connect through participant nodes can verify the integrity of the GSL and independently verify private contractual information relevant to them (in their own segregated data store: the PCS). The combination of the GSL and PCS in a Participant Node gives each stakeholder its unique view of the distributed ledger.

6.6. Direct Node Participation

ASX will be responsible for creating, maintaining, and operating the network to support the new system.

Users, if they are authorised and choose to do so, can operate a participant node to query, monitor, and interact directly with the distributed ledger.

6.6.1 Real Time Node Database

A node allows users to have a real time view into structured data relevant to them, including client and participant position data, stored in their own segregated private contract store (the PCS) within the distributed ledger. Users can replicate and query this data as needed to create a single source of truth that their other systems can rely on, thus eliminating the process of reconciliation of external data from different sources.

6.6.2 Standardized Interface

The new system provides stakeholders with cost effective direct interface capabilities. It allows users to have a common message interface provided and maintained by ASX.

6.6.3 Custom Integration Capabilities

The node has an API facility which allows users to create and maintain a custom integration to the ledger which does not require the user to adopt ISO 20022. The user will be able to leverage the DAML SDK to directly integrate a node to many downstream systems operated by the user. Additionally, existing systems and business processes can now be optimised to operate with the confidence that comes with an accurate, real time view of ledger data.

6.7. Direct Node Integration

There are several options for direct node integration, which provides each user with the flexibility as to how they interact with the system. Each of the integration options enables the user to replicate the data internally to allow it to be integrated with their downstream systems.

Option 1 - Local Node, ISO Integration



Option 2 - Local Node, DAML Integration



Option 3 (Future) - Local Node, Custom Application Extension

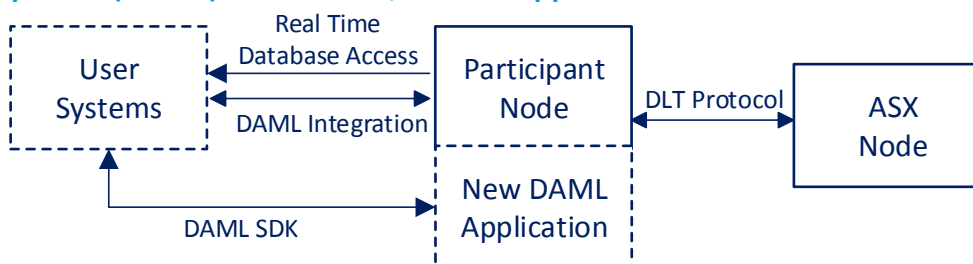

6.7.1 Option 1 – Local Node, ISO Integration

Users have the option to maintain their existing systems by connecting to the ledger with standard XML ISO 20022 messaging, and utilising on-demand access to data.

6.7.2 Option 2 – Local node, DAML Integration

Alternatively users may choose to perform a deeper integration by utilising defined DAML workflows, and bypassing XML messaging entirely.

6.7.3 Option 3 (Future) – Local Node, Custom Application Extension

In the future, users may choose to build a custom application extension using the DAML SDK. This will facilitate straight through processing of ASX information with internal systems or the development of entirely new products.

6.8. Direct Node Instruction Flow

The diagram describes the flow of an instruction in respect of an ASX participant.

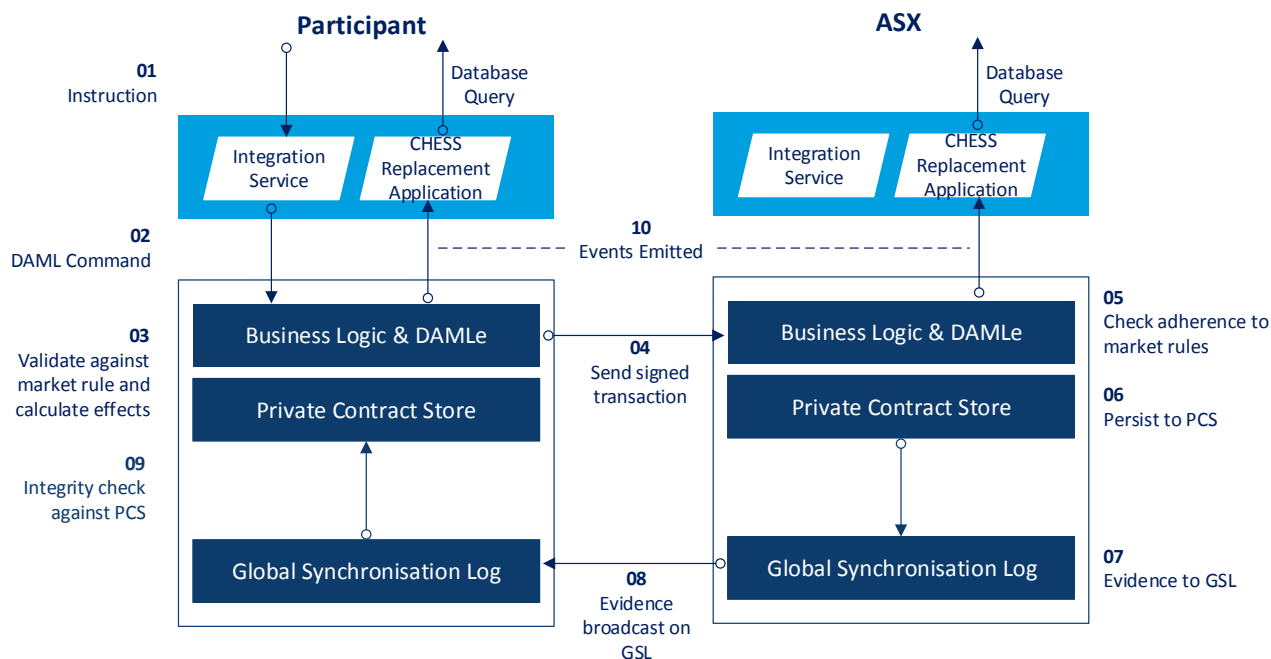

01 CHES replacement instruction sent via standard ISO 20022 messaging (or custom integration) which removes requirement for a bespoke gateway.

03,05 Shared libraries ensure market rules are interpreted correctly and consistently, eliminating business logic mismatches. The need for data reconciliation is also eliminated as workflows rely on shared, golden data record.

04 Real time communication improves operations STP and reduces timing risk. All network communications are authorized by a participant cryptographic key.

06 Privacy is maintained for all users as each participant node only receives the data that participant is a party to.

07 GSL ensures integrity and consistency of the data stored in each user's Private Contract Store.

10 Real time event notification via standardized ISO messaging (or custom integration). This allows users to integrate into their own post-trade clearing and settlement operations.

Data Base Query

The system provides real time access to data which increases the opportunities for data analysis, enhances reporting capabilities, and allows for further internal system integrations without the need to replicate and reconcile data.

While not a requirement, direct node participation will offer unique benefits to users via a standard messaging interface and access to a real time node database which is not available via message-only participation.

6.9. Integration with Existing Systems

Participant Node:

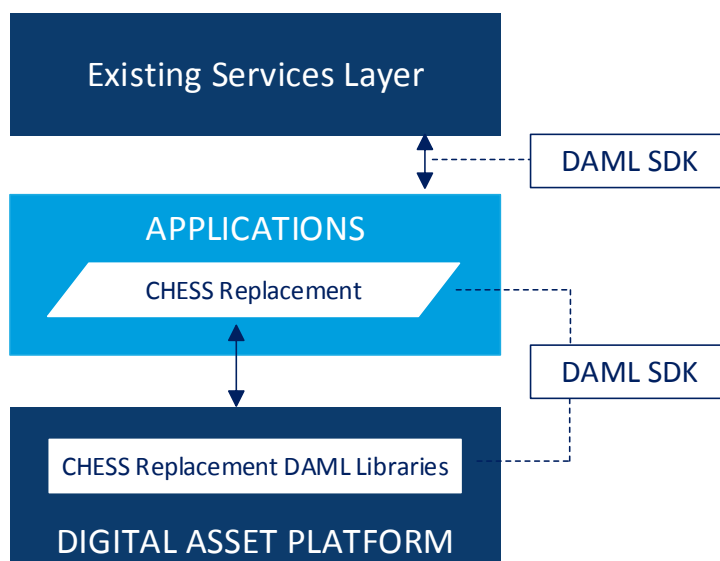

Some users will want to run a node and integrate it into their existing systems to maximize the benefits they can achieve.

DA provides a DAML SDK, which enables users to customise the integration of a node into their existing services so they can take advantage of the full straight-through processing of real time, structured data.

7. Testing and Release Management

7.1. High level indicative timeline

All dates provided in this Section 7, including in the above timeline, are indicative dates only. These dates represent ASX’s best estimate, at the time of publishing this paper, for the commencement and completion of the relevant activities.

ASX will take an agile and iterative approach to its software development and testing of the new system on the basis that it provides for a faster resolution of issues and a more efficient process. To the extent practicable, ASX will provide stable development and test environments to users. To assist user readiness for a planned six month implementation window for the new system of Q4 2020 to Q1 2021, ASX is aiming to commence incremental software drops into externally available test environments from Q2 2019 and have the majority of the functionality available for industry wide testing by Q1 2020. At a minimum, this will provide customers with eight months to conduct most functional, non-functional and formal accreditation testing.

Migration testing will begin in Q2 2020 and will culminate with migration dress rehearsal weekends in preparation for go-live. Successful industry wide testing and dress rehearsal weekends are required for go-live and will allow a primary and backup go-live weekend to be scheduled, taking industry feedback into consideration.

The first tranche of technical documentation will be released by ASX in Q4 2018. Technical documentation will include EIS to FIX and ISO message conversion relevant for the next test release enabling customers to consider the impact on their business processes. Additional tranches of technical documentation will be released ahead of subsequent test environment releases.

The diagram below presents an indicative timeline for testing, release management and implementation activities²⁷.

Indicative High-level Timeline	2018				2019				2020				2021
	Q1	Q2	Q3	Q4	Q1	Q2	Q3	Q4	Q1	Q2	Q3	Q4	Q1
ASX Analysis, Build & Test (iterative)	[Active]												
Corporate Actions STP Phase 2			[Active]										
Documentation Release (iterative)			[Active]										
Customer Analysis, Build & Test			[Active]										
Customer Development & Test Environments					[Active]								
Industry Wide Testing									[Active]				
Accreditation Testing													
Indicative Go-Live Window (Date TBC)													[Active]

²⁷ The solution is being built using an agile approach. This means that the functionality is specified, developed, and tested, in short increments (weeks). Teams of analysts and developers work to deliver the software to the ASX test environments for automated and manual testing. The software is then promoted to the customer facing environment with the accompanying documentation once it has passed ASX testing. This means that customers benefit from gaining access to functionality for development and testing earlier than if a waterfall approach was used. The system being developed is currently incomplete but is anticipated to have the majority of the functionality available for industry wide testing by Q1 2020.

ASX will make the following test environments available.

Name	Purpose	Type of Testing
Customer Development Environment	Isolated customer development and low volume testing: <ul style="list-style-type: none"> - This environment will be populated with additional PID's for customers to act as their own counterparty. - Messages will be responded to by the test system. - A PID will be included to enable dual entry message testing. - NB. SWIFT MyStandards also provides 'readiness' testing functionality for customers to test their built messages for valid format prior to functional testing in this environment. 	Functional
Industry Wide Test Environment	Fully featured environment for multi customer testing: <ul style="list-style-type: none"> - Pre-loaded with masked production data. - Integration to test trading environments. - Will provide the ability to interact with other customers to replicate production behaviour - Will also be utilised for non-functional testing activities e.g. Load, Performance etc. 	Functional and Non-Functional
Pre-Live Production Environment	Production configuration environment: <ul style="list-style-type: none"> - Regular migration rehearsals will be performed by ASX for Customers to validate the day-0 data. - Customers will perform connectivity testing and other limited pre-production tests. - NB. This environment will become the live production environment at the point of migration cutover. 	Migration and Connectivity

The Customer Development Environment will be made available from Q2 2019. Further functionality will be released in an iterative manner at regular intervals.

The first tranche of documentation for the customer test process will be released by ASX in Q2 2019, with additional tranches to follow. The documentation will include the details of the resources that will be made available to customers to support testing. Examples of the type of information that will be provided in this documentation are:

- Test scope and objectives
- Test scenarios
- Test schedule
- Support and escalation process

- Defect severity definitions
- Issue and resolution management
- Contact list
- Accreditation success criteria
- Test Environments - environment availability schedule, technical details for connectivity, environment guidelines, data migration strategy, and refresh frequency per environment.

7.2. Test approach and release management

The diagram on the following page illustrates the iterative approach that ASX will take in relation to the development and testing of the system in readiness for release. The approach is consistent with contemporary agile practices for delivering software based change. Under this approach, the system will be subject to increasing levels of testing by ASX, which will culminate in customer testing. Each level of testing will provide for an iterative feedback loop to resolve issues as they are identified.

ASX will also be utilising a high level of automation in deployment and regression testing of the system to ensure the process is as efficient as possible. The key benefits of this approach to ASX and its customers are faster resolution of issues and more timely availability of an updated system for further testing.

ASX is aiming to make functionality available to customers for testing as early as practicable. This will involve frequent releases of the software to the test environments to facilitate early validation. ASX will provide customers with the information required in advance of each release of functionality for testing to enable customers to plan and prepare for testing.

As the project is progressed, the test environments made available to customers will be increasingly rich in functionality. In the later stages of the project, customers will be able to test against a production like environment in preparation for the implementation of the new system (system 'cut-over date'). Testing during 'dress-rehearsal' weekends will be undertaken until all outstanding issues that will prevent the new system from 'going-live' are resolved.

ASX will issue guidance on the types of testing to be conducted in each environment ahead of those environments being made available to customers. The customer test environments release management approach will be issued as part of the documentation tranches to be scheduled for release following July 2018. The information to be provided in the release management documentation will include the test environment release schedule, the downtime, version support, and release notes.

To assist in planning for the delivery of the new system, ASX invites feedback on the following questions:

- Do you have specific feedback on the testing and release management strategy?
- Is there particular information that you will need to assist you with your transition planning in connection with testing and release management activities?

An iterative and agile approach to testing

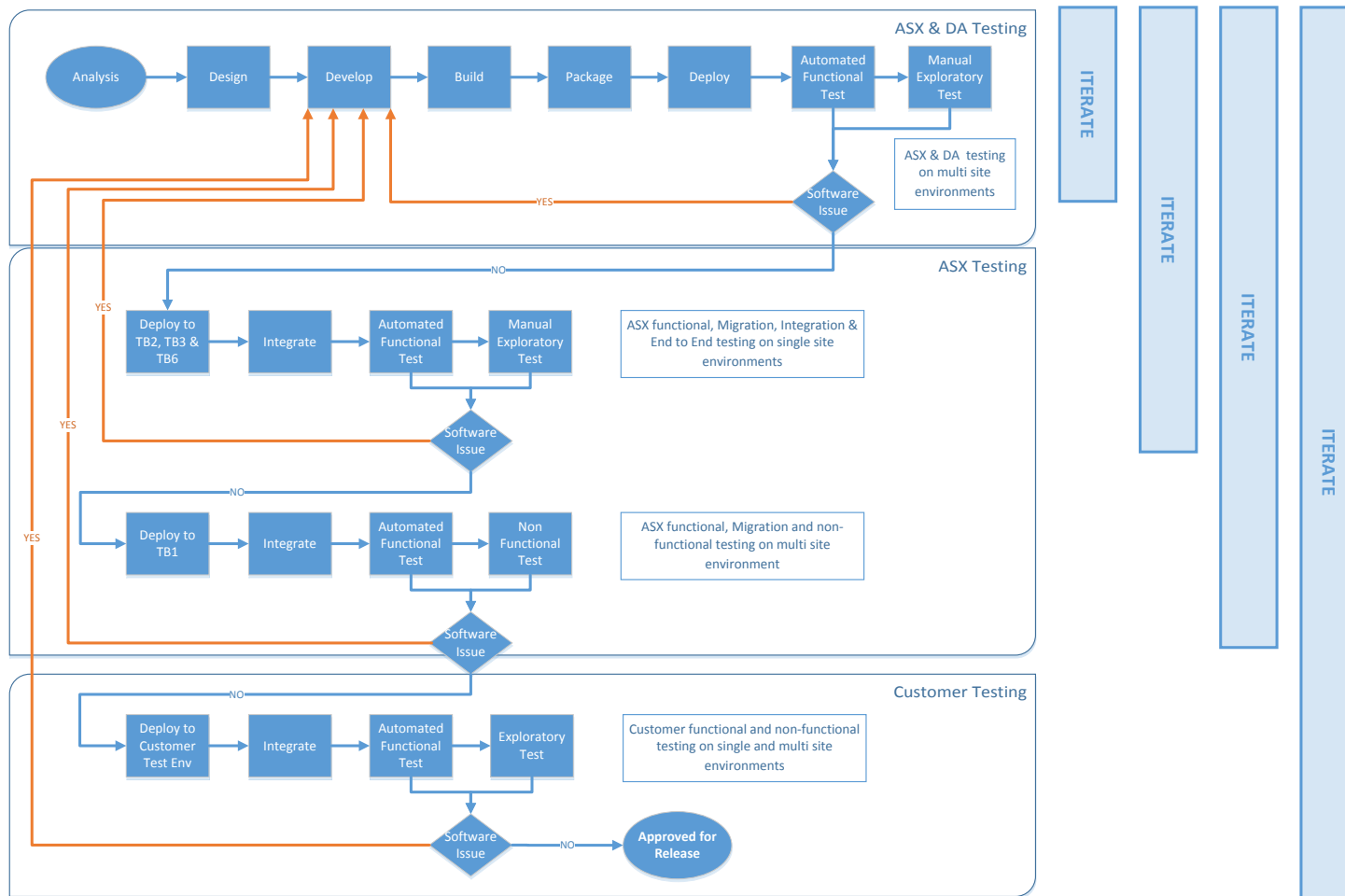

8. Migration and Implementation Approach

This section describes the overall system migration and implementation approach and also specific data migration and cleansing activities. A diagram presenting the indicative timeline for implementation activities is included in Chapter 7.

There will be a single cutover weekend from CHES to the new system. This approach is based on feedback from stakeholders through the industry working group process, a review of other large scale ISO 20022 migrations and similar transitions, and recent ASX experience with the migrations for the New Trading Platform (NTP) for ASX24 and the introduction of T+2 settlement.

The rationale for this approach is it:

- has the lowest overall risk profile of all possible approaches;
- reduces the significant complexity and additional risks of a phased transition where there are large number of transaction and stakeholder types;
- substantially reduces the operational cost and complexity for users having to run two parallel systems in Production;
- simplifies system complexity (e.g. users do not need to synchronise and reconcile multiple sources of truth);
- removes the requirement to provide protocol translation from CHES messaging to ISO 20022; and,
- allows changes to business processes to be added immediately, unconstrained by any limitations of the old system.

8.1. Approach

ASX will develop and test migration and reconciliation utilities to support rapid migration of all relevant data from the CHES system central database to the new system. This will include security reference data, participants, holders, holdings and sub-positions, cum-entitlement balances, unsettled obligations, unmatched bilateral settlements and other inflight transactions. These utilities are also expected to support the migration of data into test environments as well but it will be necessary to mask some fields to comply with privacy laws.

As part of this process ASX will:

- provide customer test facilities for functional, non-functional and migration testing;
- require vendor (and in-house system) accreditation and readiness attestation;
- require participant accreditation and readiness attestation;
- rehearse running the migration scripts and subsequent reconciliation against Production data on a daily basis in a dedicated internal test environment prior to go-live; and
- perform a partial parallel run with Production on a daily basis in a dedicated internal test environment for several months prior to go-live.

ASX will make available the actual target production environment for pre-live connectivity testing and other 'smoke' testing.

ASX will create and release a written migration plan with clear reconciliation checks and go/no go checkpoints.

Rollback from this timetable is only expected to be possible prior to the final 'go' checkpoint. After that, any subsequent issues identified will be addressed with a roll forward approach.

The migration and implementation will be rehearsed as part of an industry wide test in the actual target production environment. The environment will be reset after the test. More than one migration test may be required.

On completion of all of the above to a satisfactory level, a migration date will be set.

To assist in planning for the delivery of the new system, ASX invites feedback on the following questions:

- Do you have specific feedback on the migration and implementation approach?
- Is there particular information that you will need to assist you with your transition planning in connection with migration and implementation activities?

8.2. HIN Clean-up

The migration presents an opportunity to clean-up dormant CHES holders from the system. ASX will work with participants to define the criteria to identify the HINs that will not be migrated to the new system.

8.3. Migration of CHES Holder Registration Details

The existing rules for formatting holder registration details specify how the holder's name and address are represented in 6 rows of 30 characters (180 characters in total) and are designed so that the name and address translate directly when addressing mail.

The maximum 180 character length is considered problematic by some participants, due to the limited space. This forces participants to make arbitrary abbreviations of the name (or address) elements which can lead to mismatches when doing transfers and conversions of holdings.

The ISO 20022 standard for registration details significantly expands this 180 character limit and separates name and address into distinct fields.

The final mapping for registration details is subject to ongoing discussions with key stakeholders and industry associations. Once the new standards are agreed, the CHES replacement project team will investigate the development of migration tools and procedures to convert to the ISO 20022 format and the most effective ways to deal with any exceptions.

8.4. Post Day 1 Release Management

ASX will implement post Day 1 releases for the new system on a periodic basis, including having regard to industry demand for the relevant changes. Any such releases will be flagged at the time using the usual Quarterly Technology Upgrade Release process. Releases may be mandatory or optional enhancement releases. There will generally be no more than two mandatory releases per calendar year.

Detailed documentation on the scope, technical specifications and projected timeframes for individual mandatory and enhancement releases will be provided by ASX no later than 90 days prior to the implementation date (other than where regulatory requirements or the resolution of a critical production issue necessitate a shorter period). ASX will confirm the Go-Live date of each release by ASX Notice, generally at least two weeks prior to implementation (unless otherwise agreed with stakeholders).

9. Ongoing Stakeholder Engagement

ASX will continue to engage with stakeholders throughout the development, testing and implementation phases leading up to the go-live of the new system. This includes the formation of new industry working groups to discuss and progress key stakeholder activities to facilitate a smooth transition to the new system.

9.1. Business Committee

The Business Committee will continue to receive regular updates on the CHES replacement process, including the work of the Technical Committee on ISO 20022 and the new working groups (see below). The Committee comprises representatives of clearing and settlement participants, approved market operators and relevant industry organisations.

There are four meetings of the Business Committee scheduled during 2018.

9.2. Technical Committee (ISO 20022)

The ISO 20022 Technical Committee will continue providing a mechanism for ASX to consult interested parties on the proposed ISO 20022 messages to replace CHES messages. The Committee comprises subject matter experts from clearing and settlement participants, approved market operators, custodians, issuers' share registries, payment providers, and technology vendors.

The Committee's focus during 2018 will be on refining the proposed message suite based on the functional scope of the system and the development of documentation covering message guidelines, message maintenance and standards for message change requests and release management. ASX will also initiate a formal process with ISO for the registration of new standard post-trade messages and message extensions that will be used by the system.

There are eight meetings of the Technical Committee scheduled during 2018.

9.3. Working Groups

Two new standing working groups are to be established to facilitate transition planning. These groups will comprise a broad range of relevant stakeholders and be operated in a manner that will allow input from representatives across Australia (e.g. webinar based meetings where appropriate). The working groups will be coordinated with the ASX Technical Account Management team (TAMs) who will be available to support clients with their testing and implementation related activities.

9.3.1 Connectivity & Integration

A new Connectivity & Integration Working Group will be convened in Q3 2018. The purpose of this working group is to educate stakeholders to assist their assessment of the different connectivity options for integration and assist their system development and connectivity activities. This will include topics such as:

- what it means to take a DLT node;
- the alternatives to taking a DLT node;
- replacement options for the decommissioned CHES PC and CHES Access options; and
- the impact on vendor and proprietary systems of the new functionality or changes to existing functionality.

Key activities for the Connectivity and Integration Working Group include progressively working through technical specifications and any change management processes and tools to help stakeholders manage their

transitions. For example, the potential provision of a readiness portal to validate ISO messages prior to functional testing.

9.3.2 Implementation & Transition

A new Implementation & Transition Working Group will be convened, the timing on forming this working group will depend on stakeholder feedback as to the implementation timeline and transition approach. The purpose of this working group is to support stakeholders' implementation and transition plans. This will include topics such as:

- understanding and assessing the impact of functional and non-functional changes;
- understanding and managing the test approach;
- understanding and managing the migration approach; and
- assisting vendors' with their customer change activities.

Key activities for the Implementation & Transition Working Group include communicating the release of the roadmap for test environments, training on workflow impact and ISO impact, accreditation requirements, data cleansing activities and migration dress rehearsals.

9.3.3 Focused Stakeholder Sessions

ASX will convene a series of focused stakeholder sessions on an 'as needs' basis. For example, ASX will continue to consult with stakeholders, as appropriate, on designing solutions to Day 1 requirements. This will be done through targeted working groups, where the composition of members will vary and may be limited to a particular cohort, depending on the topic at hand. For example, ASX may convene a working group with custodians where the business requirement and/or solution only impacts custodians.

9.3.4 Approved Market Operators (AMOs)

AMOs have specific issues around how their trading systems will connect to the new clearing and settlement infrastructure, including technical access, and methods for delivery and receipt of data. As such, ASX will continue to support an AMO specific working group. AMOs will also be invited to attend the Connectivity & Integration and Implementation & Transition working groups.

9.4. Public Consultations

ASX will also issue further public consultation papers to seek feedback from stakeholders, where appropriate. This will include, for example consultation on ASX Operating Rule changes necessary as a consequence of the planned changes.

9.5. Webinars

ASX will continue to provide regular updates on the CHES Replacement project by webinar to supplement technical market notices, to clearly communicate to the market key decisions and implementation and testing timetables.

Audio recordings and a copy of presentation materials from those briefings will be made available on the dedicated CHES Replacement webpage.

Appendix 1 – Corporate Actions STP Phase 2 Project

In response to customer feedback, ASX has commenced the next phase of a project to introduce straight-through processing (STP) of the capture and dissemination of corporate action event information for all remaining corporate action events that were not covered in the first phase of the project in 2014.

In September 2014, ASX provided STP for four corporate action events - dividends, interest payments, reorganisations and cash capital returns. At that time, these four corporate action event types accounted for approximately two-thirds of corporate action volumes announced by issuers and processed by ASX. This first phase of the project introduced a new STP process for the announcement of the relevant corporate action by an issuer via a mandated smart online form, and it automated the capture of the event information in ASX's central corporate action database and delivery of a new optional ISO 20022 near real time notification service. This was added to ASX's existing suite of reference data products (ReferencePoint®).

The announcement, processing and management of corporate action events is critical to the orderly functioning of the equities market and it benefits many industry stakeholders. ASX is the primary source for corporate action information through the distribution of announcements by issuers and the provision of market data. ASX also plays an important role in the management of corporate action events over their lifecycle through its trade and post-trade platforms. Corporate actions STP will deliver the following benefits through the provision of a single source of standardised event information:

- Improve the service provided to issuers for the announcement of corporate action events and any subsequent updates related to announced events.
- Improve the timeliness, the level of information provided and accuracy associated with data capture and the processing of events. It is also expected to minimise interpretation risk associated with event information.
- Improve operational efficiency for those accessing and using corporate action event information.
- Deliver a standardised announcement, message data, and format for structured event notifications.

The second phase of the project has been timed to ensure that ASX understands stakeholders' requirements for the replacement of CHESS and the inter-relationship between the two projects.

A. Scope of Phase 2

The scope of the second phase of the project includes:

- Delivery of STP for the remaining corporate action events currently supported by ASX, including: non-renounceable and renounceable rights issues (including accelerated issues); bonus issues (including in-specie); share purchase plans; priority issues; calls; buy backs; option and convertible note expiry/conversion; takeovers; schemes; name and code changes.
- Delivery of STP for the announcement, and capture of capital placement applications and applications for the quotation of securities by ASX issuers (that is, new online smart forms covering the matters currently included in Appendix 3B to the ASX Listing Rules).
- The provision of an online form (where applicable) or other mandated announcement mechanism for issuers, the release of an equivalent PDF announcement to the Market Announcements Platform (MAP), automated data capture, support of the existing suite of reference data products and the delivery of an optional ISO 20022 format notification in near real time.

- The STP service will also be extended to cover the announcement of events by issuers of other product classes, such as, ETFs, and mFund, and the announcement of events by non-ASX affiliated AMOs on behalf of their issuers.
- ASX will also deliver a number of further enhancements to the process and events included in Phase 1 of the project to enhance the issuer experience including in relation to existing in-form validations and the design of the auto-generated PDF announcement. ASX will also review the taxation and currency data requirements for dividends with relevant stakeholders.

The other corporate action enhancements discussed in the working groups held in 2017 (that are outside the scope of STP), such as, the electronic acceptance of entitlements and payments or any other changes to existing CHES support of corporate actions, will not be progressed prior to the replacement of CHES.

A number of the corporate action business requirement inputs coming out of the working groups will be progressed through the Corporate Actions STP Phase 2 Project. These requirements fit within the scope of this project (rather than the replacement of CHES) as they relate specifically to the structure of corporate action events and how and when issuers are required to make announcements during their lifecycle, including:

- Electronic single access point for corporate action event information.
- Standardised notification of corporate action events.
- Transparency on life cycle of corporate actions, including the timely distribution of update event information.
- Introduction of a consistent cut-off date for elections under dividend reinvestment plans (DRP) and bonus share plans (BSP).
- Allocation of an ISIN for entitlements in non-renounceable issues.
- Provide security code identifier and associated corporate action record for entitlement shares issued in foreign jurisdictions through a spin-off to differentiate them from the parent financial product.

Further information about these requirements is provided below under Section C.

ASX will also review deferred settlement trading processes in the Corporate Actions STP Phase 2 Project to assess whether there are any opportunities for simplification and more streamlined timetables. This is in response to feedback received through the Settlement Enhancements Working Group.

B. Stakeholder engagement and indicative timing

The Corporate Actions STP Phase 2 Project will require significant consultation with relevant stakeholders, in particular, issuers and investors (and their agents) to ensure that the process of data capture and the information that is captured meets their needs. Other stakeholders, including existing corporate action industry consultation groups, vendors, issuers' share registries, participants and SWIFT Standards will also be included in any working groups convened to provide input to this project. Stakeholder engagement is expected to commence in the second half of this year.

The project will be progressed in parallel with the CHES replacement project, in order to achieve timely delivery to market, and to enable the ISO 20022 corporate action notification messages to be captured by the system that replaces CHES. ASX does not anticipate any need for impacted STP stakeholders to re-work messages between delivery of the STP project and the system that replaces CHES. The key impacts of the STP project are to issuers and their announcement process and to downstream ASX systems. Consumers of corporate action and other event information, whether provided in published announcements or available in optional ReferencePoint® products, should also review the changes. With an estimated 18 to 24 months to

completion²⁸, the second phase of the corporate actions project is expected to be delivered prior to the replacement of CHES.

An indicative timeline for the STP project is also included in the timeline in Chapter 7.

C. New features arising from Working Groups being implemented through Corporate Actions STP Phase 2 Project

The following descriptions explain each of the new business requirements derived from the Corporate Actions Working Group and the Settlement Enhancements Working Group which are being progressed in the Corporate Actions STP Phase 2 Project. They include the rationale, feedback received from stakeholders during the working group processes and the anticipated regulatory implications. Further regulatory analysis will be required to support implementation of the specific solution that is developed for each requirement. The availability to users of these new features is subject to the need to address any associated regulatory implications and obtaining the necessary regulatory clearances.

1. Corporate actions – Electronic single access point for corporate action event information

ASX will establish an electronic single access point for corporate action event information, which will be presented in a standardised format.

This requirement builds on similar work undertaken as part of the Corporate Actions STP Phase I Project, but extended to cover further corporate actions which were not included in the earlier project. The relevant corporate actions are: non-renounceable and renounceable rights issues (including accelerated issues), bonus issues (including in-specie), share purchase plans, priority issues, calls, buy backs, option and convertible note expiry / conversion, takeovers, schemes, name and code changes.

The corporate action event information will be collected through the issuer²⁹ populating the standardised forms for the relevant corporate action via a listed companies web portal to ASX Online which facilitates straight-through processing (STP) of that information. This includes the generation of a PDF for lodgement on ASX's Market Announcements Platform (MAP) and the provision of that information for post-trade processing in the clearing and settlement system and for external distribution by ASX to subscribers (e.g. through ReferencePoint).

Rationale

The requirement will facilitate standardisation and timely provision of content, making all information required by industry stakeholders available and accessible through a single access point.

It will also facilitate the standardisation of the format for that corporate action event information, e.g. through the adoption of ISO 20022 standard messaging.

Collection of information through standardised online forms will also create efficiencies and promote accuracy by removing manual processing currently undertaken.

Stakeholder input

The Corporate Actions Working Group requested ASX provide a "Golden Source of Truth" for the timely, complete, consistent and accurate capture of electronic announcement for all events on all Australian listing

²⁸ These dates are indicative dates only, and represent ASX's best assessment, at the time of this paper, for implementation of the new features.

²⁹ In the case of takeovers, this information may be populated by, or on behalf of, the bidder.

markets, in a standardised form, on the basis that this will ensure consistent formats for the announcement of corporate action events and make information available and accessible through an electronic solution.

Regulatory considerations

Amendments to the ASX Listing Rules (in respect of listed securities) and (to the extent relevant) ASX Operating Rules (for Warrants and AQUA products) will outline the requirements for information to be provided by issuers. Further consideration is also to be given to equivalent amendments to the ASX Settlement Operating Rules (e.g. for participant bidders in respect of a takeover).

If the electronic single access point for corporate action event information is to extend to corporate actions in respect of products that are not quoted on ASX's market (as requested by the working group), it will require the standardised online collection of information extend to corporate actions in respect of products listed and quoted on those other markets (for example, Chi-X and NSX). The extension of this requirement will be contingent on the other market operators introducing equivalent rule amendments.

2. Corporate actions – Transparency through life cycle of corporate actions

ASX will provide greater transparency on the status of a corporate action throughout its lifecycle, including any amendments to dates or criteria.

In line with the previous requirement, this requirement will also involve the collection of information changes or updates through standardised online forms which then trigger MAP announcements and the provision of that information for post-trade processing in the clearing and settlement system and for external distribution.

Providing greater transparency will apply to all corporate actions for which an electronic single access point for corporate action event information is established (i.e. non-renounceable and renounceable rights issues (including accelerated rights issues), bonus issues (including in-specie), share purchase plans, priority issues, calls, buy backs, option and convertible note expiry / conversions, takeovers, schemes, name and code changes). It will also apply to the existing 4 corporate actions for which an electronic single access point for corporate action event information was established under the STP Phase I Project (i.e. dividends, interest payments, reconstruction and return of capital).

The greater transparency is contingent on establishing an electronic single access point for corporate action event information in respect of those corporate actions.

Rationale

The requirement will assist with the standardisation and timely provision of content changes, including for scale-backs, roundings and changes to corporate action timetables and also improve transparency for the status of corporate actions.

It will also facilitate the standardisation of the format for that corporate action event information, e.g. through the adoption of ISO 20022 standard messaging.

Collection of information through standardised online forms will also create efficiencies and promote accuracy by removing manual processing currently undertaken.

Stakeholder input

The Corporate Actions Working Group requested ASX provide timely, transparent information on the progress, changes or amendments of a corporate action to better inform stakeholders and also assist in addressing inconsistencies in updates by issuers or listing markets on different aspects of a corporate action.

Regulatory considerations

Similar to the previous requirement, amendments to the ASX Listing Rules (in respect of listed securities) and (to the extent relevant) ASX Operating Rules (for Warrants and AQUA products) will be required to support this requirement. Further consideration is also to be given to equivalent amendments to the ASX Settlement Operating Rules (e.g. for participant bidders in respect of a takeover).

Additionally, the extension of this requirement to corporate actions in respect of products that are not quoted on ASX's market will also be contingent on the other market operators (such as Chi-X and NSX) introducing equivalent rule amendments.

3. Corporate actions – Standardised DRP and BSP elections

ASX will amend its operating rules to facilitate a consistent election date for DRP and BSP electronic election. This will be the record date + 1 business day.

Rationale

This requirement will supplement and support the requirement discussed above as part of Day 1 business requirements for the introduction of new functionality that will provide participants with electronic elections for DRP and BSP (Section 2.2.16).

Stakeholder input

The Corporate Actions Working Group supported the requirement on the basis that it will provide a consistent cut-off date and time for these corporate actions.

Regulatory considerations

Amendments to the ASX Listing Rules (in respect of listed securities) and (to the extent relevant) ASX Operating Rules (for Warrants and AQUA products) will support this requirement.

4. Corporate actions – ISIN for entitlement in non-renounceable rights issue

ASX (in its role as a National Numbering Agency) will allocate International Securities Identification Numbers (ISIN) codes for entitlements in non-renounceable rights issues to facilitate electronic identification and acceptances into rights issues by holders. This new ISIN will be separate to the ISIN allocated to the parent financial product.

The new ISIN will only be used during the period between the ex-date and the application close date for communications purposes only to enable settlement participants to seek instructions from their clients. There will be no trading on the new ISIN.

Rationale

The requirement will support settlement participants in obtaining client instructions from wholesale clients (particularly those clients located overseas communicating via SWIFT messages) for corporate action processing, i.e. whether to take up the new securities arising from the rights issue or, alternately, let them lapse. Currently, settlement participants often create “dummy” codes for the rights issue in order to seek instructions on the entitlements from their overseas clients. However, as they are not actual ISINs located in

an official ISIN database, overseas clients cannot identify the rights issue and therefore cannot respond automatically. This often results in the settlement participant having to phone their overseas client in order to obtain their instructions.

The requirement also ensures consistency with renounceable rights issues (for which ISIN allocation occurs), thus facilitating client instructions in respect of entitlements under rights issues on the same basis across all rights issues.

Stakeholder input

The Corporate Actions Working Group supported this requirement on the basis that it will assist obtaining client instructions on their participation in a non-renounceable rights issue in a manner consistent with renounceable rights issues.

Regulatory considerations

ASX will need to give further consideration to the recognised global standard for ISINs issued by the International Organization for Standardisation (ISO 6166) and associated guidelines issued by the Association of National Numbering Agencies (ANNA). In particular whether there is a restriction on allocating an ISIN to entitlements that are not transferable (as is the case with non-renounceable rights issues).

5. Corporate actions – Spin-offs involving entitlements in securities in foreign jurisdictions

ASX will provide a security code identifier and the associated corporate action record to allow for the identification of entitlements to shares issued in foreign jurisdictions (generally under bonus issues) and of shares subsequently issued under that entitlement.

This will allow for the entitlement to be differentiated from the parent financial product for the purpose of settlement participants obtaining client instructions on the entitlement offer and for the shares issued under that entitlement to be recorded by settlement participants in the client's portfolio of holdings.

The security code identifier is not expected to be an ISIN. This requirement is therefore anticipated to be more relevant to retail investors whose holdings are recorded against the settlement participant's nominee company and retail holders who do not rely on ISINs.

Rationale

The requirement will support settlement participants in obtaining client instructions (especially from retail clients) for corporate action processing.

It will also support portfolio holding records maintained by settlement participants for clients, in a consistent manner.

Stakeholder input

The Corporate Actions Working Group requested ASX provide a corporate action event that adjusts the "head" securities from a portfolio perspective.

Regulatory considerations

No regulatory considerations have been identified at this stage.

6. Corporate actions – Share purchase plans

ASX will standardise the election date (relative to the record date) for participating in share purchase plans (SPPs).

Rationale

The requirement is expected to streamline the processing of SPPs.

Stakeholder input

The Corporate Actions Working Group requested that SPP information captured electronically be in a standardised form on the basis that it will assist participation in SPPs.

Regulatory considerations

Amendments to the ASX Listing Rules (in respect of listed securities) and (to the extent relevant) ASX Operating Rules (for Warrants and AQUA products) will support the requirement.

7. Corporate actions – Review deferred settlement trading processes

ASX will review and undertake further consultation with stakeholders on deferred settlement trading, with a view to identifying any opportunities to improve the processes associated with the operation of these markets. Such consultation will also specifically consider the circumstances when deferred settlement trading is made available in connection with issues of securities.

Aspects of such review of deferred settlement trading may occur separate to the Corporate Actions STP Phase 2 Project, as part of other relevant ASX reviews.

Rationale

In response to recent feedback received from some stakeholders regarding the operational complexity associated with deferred settlement trading, ASX considers it timely to review the timeframes for these markets included in the timetables for corporate action events as part of the Corporate Actions STP Phase 2 Project.

Stakeholder input

The Settlement Enhancements Working Group requested that ASX consider shortening and standardising the timeframes for deferred settlement trading markets, and remove conventions for deferred settlement trading where they are no longer relevant.

Regulatory considerations

Further consultation with a broader group of stakeholders, including issuers, investors, equity trading desks at investment banks and corporate advisers, is required to obtain their input on the importance of deferred settlement trading and the opportunities to improve the operation of these markets.

The timeframes for deferred settlement trading are linked to the specific timetables for different corporate actions events and unless the overall timetables can be shortened for each of the events, shortening the period for deferred settlement trading will prima facie undermine the policy rationale for these markets. Allowing trading on a deferred settlement basis provides the following benefits to the market:

- greater liquidity in the securities;
- more efficient price discovery; and
- allowing investors to manage their exposure to market risk

Any changes to deferred settlement trading in corporate action events will be supported by changes to the ASX Listing Rules. Any changes to ASX's policy of granting conditional markets with deferred settlement trading in IPOs will be supported by a change to ASX policy guidance.

Appendix 2 – New features arising from Working Groups being implemented as ASX Business-As-Usual

The following descriptions explain each of the business requirements derived from the Corporate Actions Working Group and the Settlement Enhancements Working Group which are being progressed as ASX Business-As-Usual processes. They include the rationale, feedback received from stakeholders during the working group processes and the anticipated regulatory implications. Further regulatory analysis will be required to support implementation of the specific solution that is developed for each requirement.

These business requirements are being progressed in parallel with the CHES replacement project in order to achieve timely delivery to market. ASX has commenced engagement with stakeholders on these new features. Further consultation with relevant stakeholders is anticipated to be required. With an estimated 3 to 9 months to completion for these new features³⁰, these business requirements are expected to be delivered prior to the replacement of CHES. The availability to users of these new features is subject to the need to address any associated regulatory implications and obtaining the necessary regulatory clearances.

1. Transfers between sub-registers – Custodian off-market transfers

ASX will remove the obligation under the ASX Settlement Operating Rules for settlement participants (that are not trading participants) to provide a transfer document signed by, or on behalf of, the holder to the issuer (generally through its share registry) for the transfer of an issuer sponsored holding to a CHES holding controlled by the settlement participant.

While this requirement is predominantly applicable to transfers by custodians for wholesale clients it may also apply to margin lenders, and fund management and financial service providers for retail and wholesale clients.

The current requirement to provide a transfer document is reinforced by the Corporations Regulations which restricts issuers from effecting a transfer of financial products to a CHES holding unless the transfer is in accordance with the ASX Settlement Operating Rules³¹.

Rationale

The requirement will align the treatment of settlement participants irrespective of whether they are also trading participants.

The requirement will streamline the process for giving effect to the transfers as:

- settlement participants (that are not trading participants) will no longer be required to send their clients a transfer document for signature when they have already received their client's authorisation;
- processing times will be reduced in actioning client instructions; and
- manual processes will be removed as issuers' share registries will not need to wait for and store transfer documents.

³⁰ These dates are indicative dates only, and represent ASX's best assessment, at the time of this paper, for implementation of the new features.

³¹ Under Corporations Regulation 7.11.35 an issuer must not register or give effect to such a transfer unless the transfer is a "proper ASTC transfer". To be a "proper ASTC transfer" the transfer must be in accordance with the ASX Settlement Operating Rules or a transfer that ASX Settlement, in accordance with the ASX Settlement Operating Rules, determines to comply substantially with the applicable provisions of the operating rules and to be taken to be a "proper ASTC transfer" (refer to Corporations Regulations 1.0.02).

The removal of the obligation to produce a transfer document is not considered to involve a lessening of protections against unauthorised transfers because the registry has no means by which they can validate the signature of the transferor on the transfer document.

Warranties and indemnities under the Corporations Regulations³² from the settlement participant whose PID is included in messages for the transfer of financial products in favour of issuers and holders, that the settlement participant was authorised to effect the transfer, will also continue to apply.

Stakeholder input

The Settlement Enhancements Working Group supported the requirement on the basis that it will improve process efficiency.

ASX has separately engaged with issuers and share registries and received positive feedback on the requirement.

ASX is currently engaging with ASIC regarding the requirement.

Regulatory considerations

The additional obligations for settlement participants that are not trading participants of ASX to provide a signed transfer document are due to the absence of protections for clients under the National Guarantee Fund (NGF) in respect of fraudulent transfers by such settlement participants. In particular, the inability to make a claim under Subdivision 4.7 of the Corporations Regulations for a loss resulting from a “Dealer” transferring securities without authority. The concept of “Dealer” for the purposes of the NGF provisions in the Corporations Act³³ covers a market participant of ASX, and in some instances a participant of ASX Clear, but does not extend to an entity that is a settlement participant only³⁴.

The requirement will be supported by changes to the ASX Settlement Operating Rules. These changes will include removing the existing obligations for settlement participants that are not also a trading participant to provide to the issuer a registrable transfer document signed by the holder. They will also extend the holder’s authority warranty that is currently provided for transfers by settlement participants that are trading participants so as to apply to all settlement participants.

The Corporations Regulations³⁵ make it an offence for a settlement participant to include its PID in a message to effect a transfer without authority of the holder. Following implementation of the requirement, settlement participants will need to take their own view as to how they satisfy requirements to have the requisite holder authority to effect a transfer.

2. Corporate actions – Takeover offer

ASX will amend its operating rules to enhance the existing process for the acceptance of an off-market takeover offer in respect of CHESS holdings. The requirement aims to ensure timely actioning by sponsoring participants of takeover acceptance messages from the bidder where the takeover acceptance instructions were sent directly to the bidder (not the sponsoring participant for the CHESS holding).

³² Refer to Corporations Regulations 7.11.29 and 7.11.32.

³³ Refer to Corporations Regulations 7.5.03, 7.5.19 and 7.5.59.

³⁴ Note that if a Settlement Participant that is not subject to the NGF or other approved compensation arrangements for an AMO under Part 7.5 Division 3 of the Corporations Act establishes and maintains CHESS holdings sponsored by the participant, it is required to lodge a \$500,000 sponsorship bond with ASX Settlement. This bond is intended to apply in circumstances where a holder sponsored by that participant suffers a loss as result of the participant’s contravention of the ASX Settlement Operating Rules and there is no real prospect of the holder obtaining adequate compensation otherwise than under the sponsorship bond. Refer to ASX Settlement Operating Rule 4.9.

³⁵ Refer to Corporations Regulation 7.11.41.

For CHESS holdings, the process for accepting a takeover offer requires a sponsoring participant to send a message in CHESS to reserve those financial products in a sub-position in favour of the participant bidder. If the takeover proceeds this helps facilitate the transfer of those financial products to the bidder. If a holder with a CHESS holding sends their acceptance documentation directly to the bidder (rather than to their sponsoring participant), the bidder sends a participant bidder initiated acceptance message to the sponsoring participant, advising that this has occurred and requesting the sponsoring participant action their client's request electronically. However, if the message received by the sponsoring participant (currently MT036) is not accepted by the sponsoring participant, the holder's acceptance into the takeover offer will not be actioned.

It is currently mandatory for a sponsoring participant to accept or reject a MT036 message within 1 business day of receipt. If a sponsoring participant rejects such message 'without adequate justification' the sponsoring participant provides an indemnity to the holder and bidder against loss they may suffer as a result.

Under the amendments, an additional requirement will be imposed on sponsoring participants to seek the relevant holder's instructions when it receives an MT036 message (if it has not already been notified of its client's instructions) so as to be able to respond within 1 business day of receipt of that message, on the basis of those instructions.

As part of the amendments, ASX will also introduce an indemnity from the sponsoring participant to the bidder and holder against loss they may suffer as a result of the sponsoring participant neither accepting nor rejecting an MT036 message within 1 business day of receipt.

Rationale

The requirement will enhance the existing process for the acceptance of an off-market takeover offer and reduce risk of an entitled holder missing a takeover offer.

Stakeholder input

The Corporate Actions Working Group requested that the existing process for acceptance of an off-market takeover offer be enhanced to ensure sponsoring participants respond, in a timely fashion, to any participant bidder initiated acceptance messages, on the basis that it will assist in reducing the risk of an entitled holder missing the takeover offer.

Regulatory considerations

Amendments to ASX Settlement Operating Rules will support this requirement.

Appendix 3 – Mapping of business requirements from industry working groups

#BR	Industry working group business requirements	CP ref	New features being implemented by ASX
AS. 1	Flexible account structure hierarchy	2.2.1 2.2.2 2.4.1	Account information – Common investor number Account information – Additional investor information Account information – Aggregated view of holdings
AS. 2	Separation of clearing and settlement	2.4.4	Participant structures – Participant models for clearing and settlement services
CA. 1	Standardised notification of corporate action events and term sheet	Ann. 1 - C. 1	Corporate actions – Electronic single access point for corporate action event information
CA. 2	Standardised electronic election for dividend reinvestment plans (DRP) and bonus share plans (BSP)	2.2.16 Ann. 1 - C. 3	Corporate actions – Electronic elections for DRPs and BSPs Corporate actions – Standardised DRP and BSP elections
CA. 3	Standardised electronic acceptance process	2.2.17	Corporate actions – Electronic acceptance for entitlements offers
CA. 4	Payments for acceptances and entitlements	2.2.18	Corporate actions – Electronic payment for entitlement offers
CA. 7	Transparency on corporate actions progress	Ann. 1 - C. 2	Corporate actions – Transparency through life cycle of corporate actions
CA. 8	Takeover offer	Ann. 2 - 2	Corporate actions – Takeover offer
CA. 9	Ability to transfer CEB through the settlement system	2.2.19	Corporate actions – Transfer of CUM entitlement balance
CA. 10	ISIN – non-renounceable issues	Ann. 1 - C. 4	Corporate actions – ISIN for entitlement in non-renounceable rights issue
CA. 11	Spin-offs - (entitlement to shares in foreign jurisdictions)	Ann. 1 - C. 5	Corporate actions – Spin-offs involving entitlements in securities in foreign jurisdictions
CA. 12	Share purchase plans	2.2.2 Ann. 1 - C. 6	Account information – Additional investor information Corporate actions – Share purchase plans
CA. 14	Electronic claims process	2.4.2	Corporate actions – Electronic processing of dividend claims
CA. 15	Proxy voting	2.4.3	Corporate actions – Electronic proxy voting
TC. 1	Standardised registration details	2.2.4	Account information – Standardised registration details
TC. 2	Custodian off market transfers	Ann. 2 - 1	Transfers between sub-registers – Custodian off-market transfers
SE. 1	Issuer sponsored SRN transparency	2.2.10	Pre-settlement – Single access point to validate SRN
SE. 2	Locking retail securities	2.2.5 2.2.6	Pre-settlement – Settlement lock for CHES holdings Pre-settlement – Settlement lock for issuer sponsored holdings
SE. 3	Shorter settlement cycles	2.2.9	Pre-settlement – Additional preliminary payment notifications
SE. 4	Early settlement (clients)	2.2.14	Settlement – Optional early settlement
SE. 6	Bilateral DvP settlements outside of “batch”	2.2.11	Settlement - Non-batch DvP bilateral settlement
SE. 7	“Pre” matching bilateral transactions	2.2.7	Pre-settlement – Bilateral transaction matching

#BR	Industry working group business requirements	CP ref	New features being implemented by ASX
SE. 8	Tolerance model	2.2.7	Pre-settlement – Bilateral transaction matching
SE. 10	Enhanced matching criteria for bilateral settlements	2.2.7	Pre-settlement – Bilateral transaction matching
SE. 11	Additional processing during the daily settlement cycle	2.2.12	Settlement – Settlement message enhancements
SE. 12	Streamline deferred trading and settlement processes	Ann. 1 - C. 7	Corporate actions – Review deferred settlement trading processes
SE. 13	Give up and take up functionality	2.2.8	Pre-settlement – Transfer of novated equities transactions between clearing participants
SE. 14	Support multi-currency settlements	2.2.13	Settlement – Settlement in foreign currencies
SE. 15	Settlement message management	2.2.12	Settlement – Settlement message enhancements
DS. 1	Message delivery priority	2.2.12	Settlement – Settlement message enhancements
DS. 3	Centralised data capture and storage	2.2.3	Account information – Centralised data capture and storage
DS. 4	Real-time holding balances	2.2.20	Reporting – Continuous holding balance information

NB: The two letters at the start of the #BRs in the first column above (e.g. **AS.1**) are abbreviations for the working group that identified the relevant business requirement. These refer to:

- AS: Account Structures and Participant Models Working Group;
- CA: Corporate Actions Working Group;
- TC: Transfers and Conversions Working Group;
- SE: Settlement Enhancements Working Group; and
- DC: Data Storage, Delivery and Reporting Working Group.

Acronyms

ABN	Australian Business Number
ACCC	Australian Competition and Consumer Commission
AFSL	Australian Financial Services Licence
AGB	Australian Government Bond
AMO	Approved Market Operator
AMQP	Advanced Message Queuing Protocol
AMSLA	Australian Master Securities Lending Agreement
ANNA	Association of National Numbering Agencies
API	Application Programming Interface
ASIC	Australian Securities and Investments Commission
ASX	Australian Securities Exchange
ATO	Australian Taxation Office
AWS	Amazon Web Services
BSP	Bonus Share Plan
CCP	Central Counterparty
CDI	CHESS Depository Interest
CEB	Cum Entitlement Balance
CHESS	Clearing House Electronic Subregister System
CIN	Common Investor Number
CMM	Cash Market Margin
CRS	Common Reporting Standard
CS	Clearing and Settlement Facility
DA	Digital Asset
DAML	Digital Asset Modelling Language
DAML SDK	DAML Software Development Kit
DLT	Distributed Ledger Technology
DRP	Dividend Reinvestment Plan
DvP	Delivery versus Payment
EIS	CHESS External Interface Specification
ETF	Exchange Traded Fund
ETO	Exchange Traded Option
ETP	Exchange Traded Product
FATCA	Foreign Account Tax Compliance Act
FIX	Financial Information eXchange Protocol
FSS	(RBA) Financial Stability Standard
FTP	File Transfer Protocol
FUM	Funds Under Management
GSL	Global Synchronisation Log
HIN	CHESS Holder Identification Number
ISIN	International Securities Identification Number
ISO	International Organisation for Standardisation
LEI	Legal Entity Identifier
MAP	Market Announcements Platform
MIRs	(ASIC) Market Integrity Rules
NGF	National Guarantee Fund

NFR	Non-Functional Requirements
NPP	New Payments Platform
NTP	New Trading Platform
P2P	Principal to Principal
PCS	Private Contract Store
PFMI	IOSCO Principles for Financial Market Infrastructure
PID	Participant Identifier
PISP	Product Issuer Settlement Participant
PKI	Public Key Infrastructure
PSNA	Payment Systems and Netting Act 1998
RBA	Reserve Bank of Australia
SDK	Software Development Kit
sFTP	Secure File Transfer Protocol
SMSF	Self-Managed Superannuation Fund
SPP	Share Purchase Plan
SRN	Securityholder Reference Number
STP	Straight-Through Processing
T+2	Trade Day + 2 business days
T2S	TARGET2 Securities
TAS	Trade Acceptance Service
TFN	Tax File Number
VPN	Virtual Private Network
XML	eXtensible Markup Language